

## PAPER NAME

**Performance Comparison of The Implementations of Single Row Power Weeder (Single Engine) and Multi-R**

## AUTHOR

**Mareli Telaumbanua**

## WORD COUNT

**5497 Words**

## CHARACTER COUNT

**28307 Characters**

## PAGE COUNT

**15 Pages**

## FILE SIZE

**787.3KB**

## SUBMISSION DATE

**Sep 7, 2022 3:52 PM GMT+7**

## REPORT DATE

**Sep 7, 2022 3:53 PM GMT+7**

● **18% Overall Similarity**

The combined total of all matches, including overlapping sources, for each database.

- 16% Internet database
- 16% Publications database
- Crossref database
- Crossref Posted Content database
- 15% Submitted Works database

● **Excluded from Similarity Report**

- Bibliographic material
- Quoted material
- Manually excluded sources

PAPER • OPEN ACCESS

## Performance Comparison of the Implementations of Single Row Power Weeder (Single Engine) and Multi-Row Power Weeder (Twin-Engine) in Rice Fields

19 Cite this article: M Telaumbanua *et al* 2022 *IOP Conf. Ser.: Earth Environ. Sci.* **1038** 012061

16 View the [article online](#) for updates and enhancements.

You may also like

- 22 [Feedback stabilization of ideal kink and resistive wall modes in tokamak plasmas with negative triangularity](#)  
Jing Ren, Yueqiang Liu, Yue Liu *et al.*
- 15 [Application of oxyfluorfen and pendimethalin to control weeds on soybean plantation](#)  
H Hasanuddin, G Erida, S Hafsah *et al.*
- 20 [ACS—Realization of an adaptive concept using pressure actuated cellular structures](#)  
B Gramüller, J Boblenz and C Hühne



### 242nd ECS Meeting

Oct 9 – 13, 2022 • Atlanta, GA, US

Early hotel & registration pricing ends September 12

Presenting more than 2,400 technical abstracts in 50 symposia

The meeting for industry & researchers in

**BATTERIES**  
**ENERGY TECHNOLOGY**  
**SENSORS AND MORE!**

 Register now!



**ECS Plenary Lecture featuring M. Stanley Whittingham,**  
Binghamton University  
Nobel Laureate –  
2019 Nobel Prize in Chemistry



# Performance Comparison of the Implementations of Single Row Power Weeder (Single Engine) and Multi-Row Power Weeder (Twin-Engine) in Rice Fields

M Telaumbanua<sup>1\*</sup>, Witaningsih<sup>1</sup>, B Lanya<sup>1</sup>, A Haryanto<sup>1</sup>, S Suharyatun<sup>1</sup>, F K Wisnu<sup>1</sup>

<sup>1</sup>Agricultural Engineering Departement, University of Lampung, Bandar Lampung, Indonesia  
E-mail: marelitelaumbanua@gmail.com

**Abstract.** Weeding rice weeds is done to reduce and prevent the competition of nutrients absorption between weeds/grass and rice plants. Weed control can be applied through various techniques, including pulling and piling the weeds into the soil. Weeds buried in the soil can be decomposed and become nutrients for rice plants. One application of technology used in weeding weeds is the use of single row power weeder (*single engine*) and multi-row power weeder (*twin-engine*). The research aimed to compare the performance of using a single row power weeder (*single engine*) and a multi-row power weeder (*twin-engine*) in rice fields. The multi-row power weeder was designed by combining a single row power weeder. This research was conducted by testing the performance of the power weeder in rice fields in an area of 14 m x 4 m for each replication. The total area of land used was 560 m<sup>2</sup> with five experimental replicates. Weeding activities were carried out on rice plants aged 30 DAP. The results showed a successive comparison between the performance of the single row power weeder (*single engine*) and the multi-row power weeder (*twin-engine*), such as the theoretical working capacity was 0.037 ha/hour and 0.054 ha/hour, effective working capacity was 11.11 minutes and 9.78 minutes, the efficiency of the weeder performance was 82.48% and 64.87%, fuel consumption was 1.07 liters/hour and 1.92 liters/hour, and the success rate of weeding was 64.41 % and 59.77 %. The calculation results of the plant damage levels were 15 plants and 31 plants, while the mudding index values were 75.26% and 77.62%. The results of this study showed that the advantages of using a single row power weeder were on the parameters of effective working capacity, weeding efficiency, fuel, weeding success, and low plant damage. The advantages of the multi-row power weeder were the parameters of theoretical working capacity, effective working capacity, and mudding index.

## 1. Introduction

Weeds are plants whose growth is not desired. Generally, weed growth is faster than cultivated plants. Weeding is a step to reduce the growth of weeds which are often referred to as nuisance plants. It aims to reduce and prevent competition for nutrients, water, oxygen in the soil, light between rice plants and weeds that grow together. In addition, the uncontrolled growth of weeds can cause the pest population in the crop cultivation area to increase. Some types of weeds are considered as nests or lures for some pests.

Control of weeds that grow simultaneously with rice plants can be carried out periodically. Some steps can be taken pulling out, removing, or submerging weeds into the soil [1]. Weeds that have been buried in the soil can be decomposed into nutrients that rice plants can absorb. Several

alternative ways can be done to weed weeds manually and mechanically. However, manual weeding is not optimal for use on land for plant cultivation which tends to be more comprehensive. Mechanical steps taken for weeding weeds are weeding using a power weeder that uses a fuel motor. The use of a power weeder is considered a step to improve work efficiency in the field because it can increase the effectiveness and performance of the weeding process [2]. Improving the performance of the weeding process has an impact on increasing labor productivity and rice production [3].

Generally, the power weeder found at the farm level is a single row power weeder using a single engine. However, using a single row power weeder is considered to be less fast than a double row. It becomes the basis for researchers to design a double row power weeder unit by utilizing a twin-engine power weeder to weed weeds in rice plants. This research objective was to obtain a performance comparison between the use of a power weeder single row using a single-engine and a multi-row power weeder using a twin-engine in weeding rice plants. The twin-engine power weeder is assembled through the incorporation of a single-engine power weeder. The novelty of this research is the design and performance testing of single row and multi-row weeder machines to improve farmer performance. In this study, the power weeder worked using a type 2 stroke engine, a cylinder volume of 30.5 cc for 1 unit of weeder. The multiple power weeder was designed to be sturdy and portable so that it could be disassembled. The advantage of the portable system on this multiple power weeder was that it made weeding distance easily adjusted between rice plants.

Several studies have been conducted before analyzing the performance of motorized weeding machines before and after modification [4]. In this study, modification of weeding equipment was able to increase the success of weeding by 78%. Another study was about modifications to motorized weeders for paddy fields [5]. Research on the technical and economic aspects of weeders in rain-fed rice fields has also been carried out [6]. A design for weeding systems in paddy fields has been carried out to support weeding operations in paddy fields [7]. In addition, noise and vibration research on the use of hand tractors has been carried out [8]. Excessive vibration and noise could cause high levels of fatigue and result in health problems. Research on improving work systems to reduce fatigue in doing work has also been done [9]. Another study is about the modification of gasrok for weeding. The use of gasrok has an impact on lower operating costs for farmers [10].

This research could be helpful as a reference on implementing a weeder (machine tool) to increase productivity in agriculture. In addition, this research was also helpful as a basis for further research for duplicating implements or suitable weeding discs using a single combustion engine. Through this research, we found a technology that weeding using a combustion engine using duplicated implements makes weeding more efficient and increases farmer productivity. The application of automation and control systems can be applied to the weeder, so that operational activities do not require manpower [11, 12]. The application of the future weed control system can embed artificial intelligence to predict movement using artificial neural networks so as to reduce operator involvement in the field and reduce operational costs [13, 14]. This is certainly very helpful for the lack of labor in agriculture in various regions in Indonesia.

## 2. Material and Method

### 2.1. Places, Materials, and Equipment

The research was conducted at the Agricultural Power and Machineries Laboratory, Department of Agricultural Engineering, Faculty of Agriculture, University of Lampung. The tool testing was carried out in rice fields in Cipta Waras Village, Gedung Surian District, West Lampung Regency, Lampung Province, Indonesia. The tools used in this research were single-row power weeder, multi-row power weeder, stopwatch, ruler, meter, stake, rope, fuel in the form of gasoline mixed with oil

with a ratio of 25:1, IBM SPSS Statistics 22.0 application, camera, sound level meter, smartwatch, 100 cc tube, and stationery. The material used was rice weeds with a plant age of 30 days.

## 2.2. Stages of Research and Tool Testing

The research was conducted on two weeding tools, namely single row and multi-row power weeders. The power weeder used was a single groove power weeder with the brand Daun Mas type MH1R. Multi-row power weeders are two combined power weeder machines, one Daun Mas type MH1R type. The research stage started from the assembly of the implemented power weeder. Next was the making of an observation plot with an area of 14 x 4 m for each test. Then, the total population of rice plants was calculated in each observation plot. Furthermore, preparation of weeding equipment and weeder testing was carried out. The weeding pattern between the single-engine and double-engine weeders was comparable. Each row was weeded without any overlapping weeding between treatments. In testing the equipment, the data taken included working capacity (effective and theoretical), tool efficiency, the percentage of successful weeding, crop damage, mudding index, and fuel consumption.

The measurement of the theoretical working capacity can be carried out using the equation [15]:

$$KT = 0.36 \times V \times W \dots\dots\dots(1)$$

Where:

- KT : Theoretical working capacity (ha/hour)
- V : Speed (m/sec)
- W : Tool working width (m)

The values of effective working capacity can be obtained by calculating the weeded land area divided by total time or used the equation below:

$$KE = \frac{A}{t} \dots\dots\dots(2)$$

Where:

- KE : Effective working capacity (ha/hour)
- A : Land area (ha)
- t : Total operating time (hours)

The values of the tool efficiency can be obtained by comparing the effective working capacity to the theoretical working capacity, or using the equation:

$$E = \frac{KE}{KT} \times 100\% \dots\dots\dots(3)$$

Where:

- E : Field efficiency (%)
- KE : Effective working capacity (ha/hour)
- KT : Theoretical working capacity (ha/hour)

Fuel consumption is calculated on both *power weeder* tools with the same treatments. *i.e.*, before weeding, the fuel is fully filled. Then, after it has operated, it will be fully filled again. Most fuels filled after operating were recorded as the amount of fuel used. The fuel discharge can be calculated by the equation [16]:

$$Q = \frac{Vol}{T} \dots\dots\dots(4)$$

Where:

- Q : Fuel Discharge (liter/hour)
- Vol : Volume of fuel used (liter)
- T : The time used (hour)

A weeding success rate was carried out by measuring the total weight of weeds and the weight of the weeding weeds. The percentage of the weeding success rate can be measured by using the equation:

$$Gh = \left(\frac{Gt}{Gp}\right) \times 100 \% \dots\dots\dots(5)$$

Where:

- Gh : Percentage of weeding weeds weight (%)
- Gt : Weeding weeds weight (kg)
- Gp : Total weight weeds (kg)

The percentage of crop damage was obtained by comparing the number of crop damage and the principal crops or using the equation [17]:

$$PKT = \frac{TR}{TP} \times 100 \% \dots\dots\dots(6)$$

Where:

- PKT: Percentage of crop damage (%)
- TR : Crop damage due to the operating tools (stem)
- TP : The number of the principal crops (stem)

The calculation of the mudding index was carried out by taking the groundwater suspension from the mudding using a plastic tube that has a volume size of 100 cc on the mud's surface with the tube positioned horizontally in the mud. The two tube holes were tightly closed to prevent leakage. Then, it will be left for 48 hours. Thus, the soil in the tube fell and settled. The amount of soil volume in the tube will be recorded, and the mudding index can be calculated by using the following equation [18].

$$IP = \frac{Vs}{Vt} \times 100\% \dots\dots\dots(7)$$

Where:

- IP : The mudding index (%)
- Vs : Decreased soil volume
- Vt : The total volume of suspension samples

### 2.3. Data Analysis

Data analysis was conducted with the analysis method of the Independent T-Test at the real level using the IBM SPSS Statistics 22 application.

## 3. Results and Discussion

### 3.1. Design Results

The implemented power weeder design consisted of a single-row engine power weeder. A multi-row double-engine weeder was combined with two single-row single-engine weeder units. The joining used iron pipe material with a diameter of 5 cm and a pipe thickness of 2 mm. The combination of these two weeder units used three coupling points to strengthen during operation. The throttle lever has been adjusted proportionally so that the speeds between engines have the same RPM. The combination of these tools was in a portable design so that the weeding process used a double-engine weeder that can adjust to the spacing of plants in various land conditions (Figure 1).

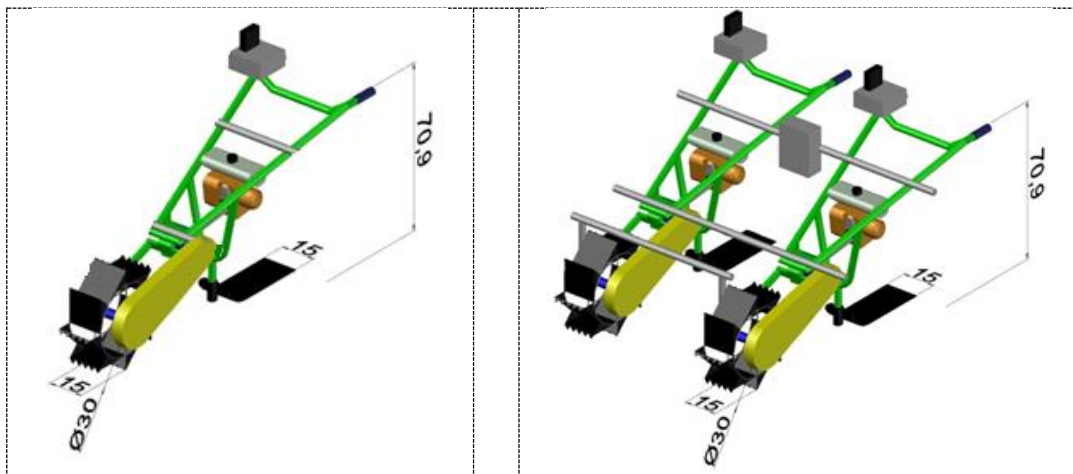
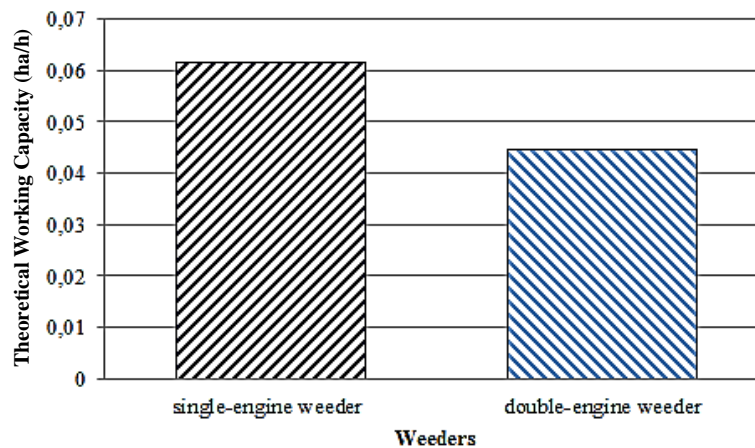

**Figure 1.** (a) Single-row single-engine weeder and (b) Multi-row double-engine weeder

Tests on single and multiple power weeders were carried out at a spacing between 25 -30 cm. The distance was according to the spacing of rice in Indonesia and the width of the weeding wheel.

### 3.2. Theoretical Working Capacity

Theoretical working capacity was obtained from the calculation of the tool speed (m/s) multiplied by the working width of the tool (m). The tool's speed (m/s) was obtained from calculating the length of the track (m) divided by the operating time of the tool on one track. Based on the results of the measurements made by each tool were 0.69 m/s and 0.50 m/s. The results of the calculation of theoretical working capacity can be seen in Figure 2.



**Figure 2.** Theoretical working capacity of each weeder

Figure 2 shows that the theoretical working capacity of the single and double power weeder mechanical weeder was 0.062 ha/hour and 0.045 ha/hour, respectively. Each tool had a different theoretical working capacity value, with the theoretical working capacity value on a single power weeder being higher than that of the double power weeder. According to the results of research that has been done, it was influenced by the worker's physical condition, the level of ability, skill, and work habits of the operator [19]. Other factors that were also considered to affect the ability to work are land conditions (soil type, mud layer) and the value of weed density.

The theoretical work capacity data analysis utilized an independent sample T-test on the SPSS application with a two-way (two-tailed) significance value of  $0.000 < 0.05$ . The results of the Independent Sample T-test test are shown in Table 1.

Table 1. Results of independent sample T-test of theoretical working capacity

		theoretical working capacity		
		Equal variances assumed	Equal variances not assumed	
Levene's Test for Equality of Variances	F	0.005		
	Sig.	0.947		
t-test for Equality of Means	T	3.776	3.776	
	Df	8	8	
	Sig. (2-tailed)	0.005	0.005	
	Mean Difference	0.0168	0.0168	
	Std. Error Difference	0.00445	0.00445	
	95% Confidence Interval of the Difference	Lower	0.00654	0.00653
		Upper	0.02706	0.02706

Table 1 is the main table of the independent sample t-test analysis. It can be seen that the two-way (two-tailed) significance value was  $0.005 < 0.05$ . Thus, there was a significant difference in point scores between the single power weeder group and the multiple power weeder groups.

### 3.3. Effective Working Capacity

Effective working capacity was the average value of the workability of a tool to complete its work or the average area of work per amount of time required. The value of effective working capacity is shown in Figure 3.

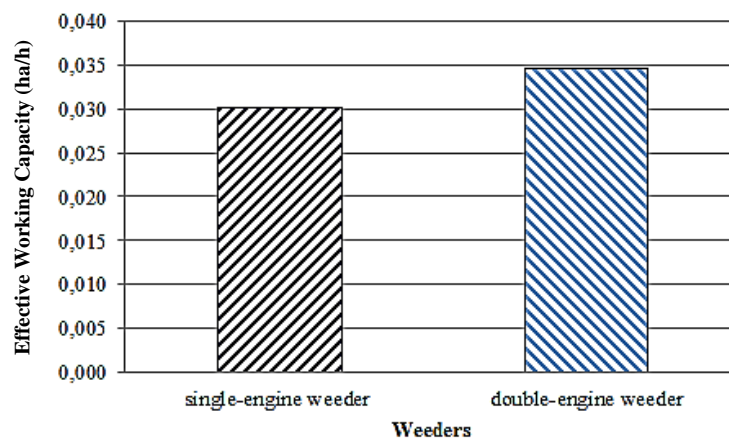

Figure 3. Effective working capacity of each weeder

The double power weeder owned the average value of the highest effective working capacity with a value of 0.035 ha/hour. In contrast, in the single power weeder, the average value of the effective working capacity was 0.030 ha/hour. The average effective working value was 0.0377 ha/hour related to the power weeder tool in previous studies [6]. Effective working capacity data analysis was carried out through an independent sample T-test on the SPSS application with a two-



way (two-tailed) significance value of  $0.000 < 0.05$ . The results of the Independent Sample T-Test test are shown in Table 2.

Table 2. Results of independent sample T-test of effective working capacity

		effective working capacity		
		Equal variances assumed	Equal variances not assumed	
Levene's Test for Equality of Variances	F	3.036		
	Sig.	0.12		
t-test for Equality of Means	T	-1.64	-1.64	
	Df	8	5.202	
	Sig. (2-tailed)	0.14	0.16	
	Mean Difference	-0.0044	-0.0044	
	Std. Error Difference	0.0027	0.0027	
	95% Confidence Interval of the Difference	Lower	-0.0106	-0.0112
		Upper	0.001788	0.002418

Based on Table 2, there was no significant difference between the value of the effective working capacity of the single power weeder and the double power weeder. It was evident from the significant two-way (two-tailed) values, namely 0.140 and 0.160, where both values were more significant than the alpha value of 0.05.

### 3.4. Weeding Tool Efficiency

The weeding tool's efficiency was influenced by the ability to work effectively and the ability to work theoretically. The total effective working ability was calculated by working time on flat ground, turning time, and resting time so that the effective working time tended to be more significant. The efficiency of each tool is shown in Figure 4.

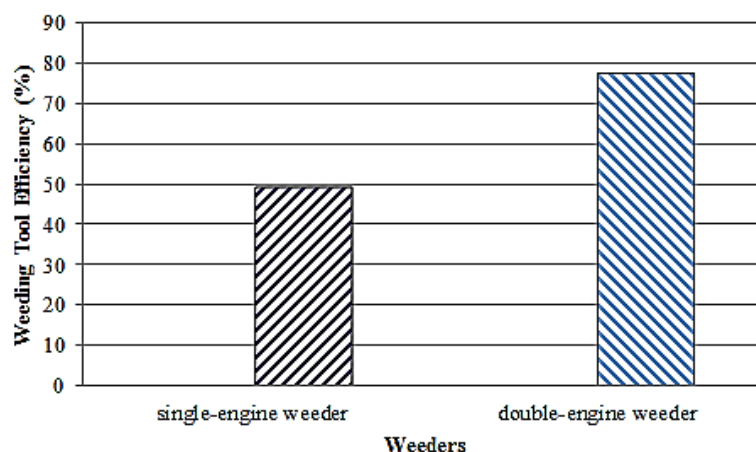

Figure 4. The efficiency of the weeding tool.

The highest efficiency value was achieved by a double power weeder of 77.84%, while the efficiency value of a single power weeder was 49.49%. However, the value of weeding efficiency produced by the mechanical device has not yet reached its maximum value. The experimental images

used were narrow and limited, and the operator's ability to operate the tool was still limited. Table 3 showed an independent sample T-test analysis for the value of the efficiency of the weeding tool used an alpha of 5% (0.05).

Table 3. The results of the independent sample t-test of the weeding tool efficiency.

		The efficiency of the weeding tool		
		Equal variances assumed	Equal variances not assumed	
Levene's Test for Equality of Variances	F	2		
	Sig.	0.195		
t-test for Equality of Means	T	-2.734	-2.734	
	Df	8	4.828	
	Sig. (2-tailed)	0.026	0.043	
	Mean Difference	-28.3534	-28.3534	
	Std. Error Difference	10.371487	10.371487	
	95% Confidence Interval of the Difference	Lower	-52.270092	-55.302512
	Upper	-4.436708	-1.404288	

The table showed a significant difference between the single power weeder and double power weeder groups because the two-way (two-tailed) significance values were 0.026 and 0.043, where both values were smaller than the alpha value, which was 0.05.

In addition, based on the descriptive value, it was evident that using a double power weeder had a more excellent efficiency value than a single power weeder.

### 3.5. Fuel Consumption

Consumption of fuel used in this research was the volume of fuel in the form of a mixture of gasoline and oil mixed with a ratio of 25: 1, which was used during the tool's operation in each observation plot. The amount of fuel volume was obtained by filling it thoroughly before weeding. Then after it was operated, each tool was filled again until it was complete. The amount of fuel filled after the operation was recorded as the amount of fuel used. Consumption of fuel use is presented in Figure 5.

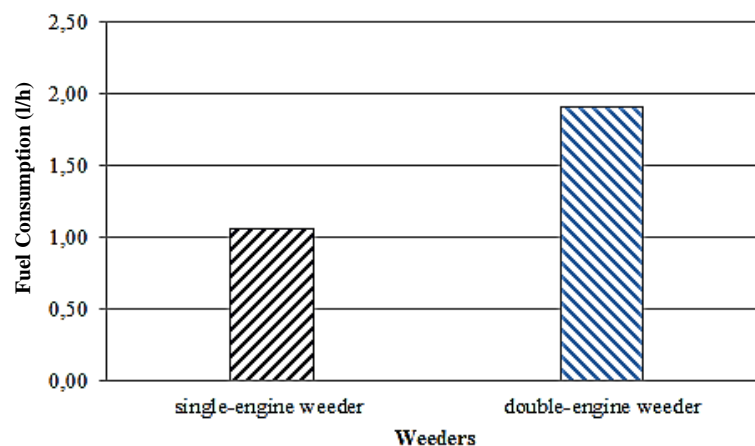

Figure 5. Consumption of fuel use

The average amount of fuel consumed by the double power weeder was 1.92 liters/hour, while the single power weeder was 1.07 liters/hour. It was because there were two driving forces on the

double power weeder to use more fuel. Therefore, the amount of power weeder affected the fuel consumption used.

Analysis of fuel consumption data was carried out using an independent sample T-test on the SPSS application with a two-way (two-tailed) significance value of  $0.000 < 0.05$ . The results of the Independent Sample T-Test test are shown in Table 4.

Table 4. Results of the Independent Sample T-Test of Fuel Consumption

		Fuel Consumption		
		Equal variances assumed	Equal variances not assumed	
Levene's Test for Equality of Variances	F	2.548		
	Sig.	0.149		
t-test for Equality of Means	T	-3.17	-3.17	
	Df	8	6.02	
	Sig. (2-tailed)	0.013	0.019	
	Mean Difference	-0.85	-0.85	
	Std. Error Difference	0.269	0.269	
	95% Confidence Interval of the Difference	Lower	-1.47	-1.51
		Upper	-0.23	-0.19

Based on Table 4, there were significant differences in fuel consumption value between single power weeder and double power weeder. It was evident from the two-way (two-tailed) significant values, namely 0.013 and 0.019, where both values were smaller than 0.05. In addition, based on the descriptive value, it was proven that using a double power weeder consumed more fuel.

3.6. Weeding Success Rate

The weeding success rate was obtained by calculating the percentage of weeds weeded in an observation plot. In this research, the number of weeds was calculated based on weed weights and the total weed weights. Data on the success rate of weeding is shown in Figure 6.

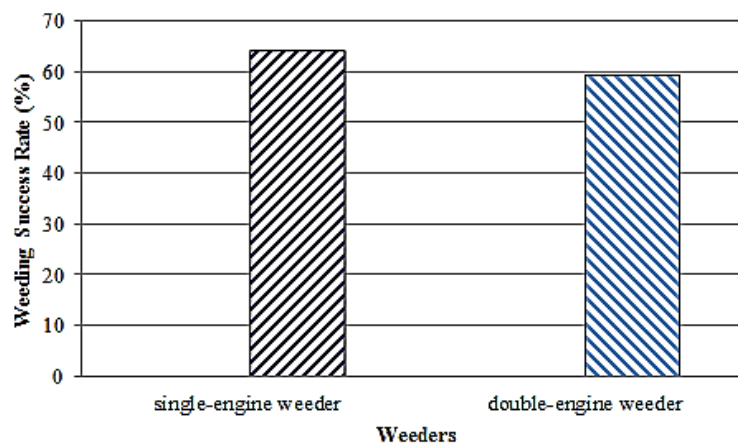

Figure 6. The success rate of weeding

The highest percentage of weeding success rate was achieved by a single power weeder of 64.41%, and the lowest value was obtained by a double power weeder of 59.77%. It was due to differences in weed density in each plot and the operator's ability to operate the weeding equipment. In the experimental plot of the single power weeder, the weed density was high enough that many weeds were easy to weed. In contrast, in the experimental plot of the double power weeder, the weeds grew quite far apart. In addition, the single power weeder was more straightforward to operate than the double power weeder. The double power weeder required two people to operate it because the tool's weight was quite heavy. Table 5 shows an independent sample T-test analysis for the value of the success rate of weeding equipment using an alpha of 5% (0.05).

Table 5. The results of the independent sample T-test of the success rate of the weeding tool

		The success rate of weeding		
		Equal variances assumed	Equal variances not assumed	
Levene's Test for Equality of Variances	F	0.054		
	Sig.	0.823		
t-test for Equality of Means	T	0.59	0.59	
	Df	8	6.936	
	Sig. (2-tailed)	0.571	0.574	
	Mean Difference	4.636	4.636	
	Std. Error Difference	7.855	7.855	
	95% Confidence Interval of the Difference	Lower	-13.479	-13.974
		Upper	22.751	23.246

Based on Table 5, there was no significant difference between the success rate of single power weeder and double power weeder. It was evident from the two-way (two-tailed) significant values, namely 0.571 and 0.574, where both values were more significant than the alpha value of 0.05.

3.7. Crop Damage Rate

The crop damage rate was obtained from the calculation of the percentage of the crop damage numbers due to the use of weeding equipment. Percentage of crop damage was obtained by comparing the number of crop damage to the number of principal crops. The percentage of crop damage is presented in Figure 7.

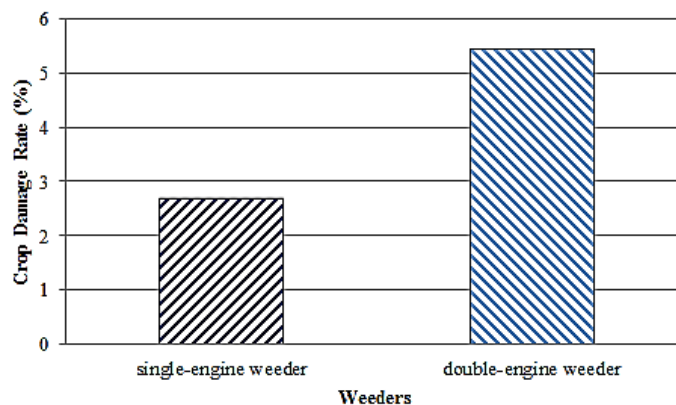

Figure 7. Percentage of Crop Damage

The highest level of crop damage resulting from a double power weeder was 5.46%, while the level of crop damage to a single power weeder was 2.71%. It was due to the lack of operator capability in operating the double power weeder because its heavyweight made it more challenging to control than other weeders. Data analysis on the level of crop damage was carried out utilizing an independent sample T-test on the SPSS application with a two-way (two-tailed) significance value of  $0.000 < 0.05$ . The results of the Independent Sample T-Test test are shown in Table 6.

Table 6. Results of independent sample T-test on the crop damage rate

		The crop damage rate		
		Equal variances assumed	Equal variances not assumed	
Levene's Test for Equality of Variances	F	0.261		
	Sig.	0.623		
t-test for Equality of Means	T	3.688	3.688	
	Df	8	7.651	
	Sig. (2-tailed)	0.006	0.007	
	Mean Difference	2.752	2.752	
	Std. Error Difference	0.746279	0.746279	
	95% Confidence Interval of the Difference	Lower	1.031	1.017
		Upper	4.473	4.487

Table 6 shows the results of the independent sample t-test analysis. It can be seen that the two-way (two-tailed) significance value of 0.006 and 0.007 where both values were smaller than the alpha value of 0.05, so there was a significant difference in point scores between the single power weeder and double power weeder groups.

### 3.8. Mudding Index

The mudding index in this study was obtained from calculating the volume of the soil suspension samples taken after the weeding process from each weeding tool. Figure 8 shows the mudding index value of each weeder.

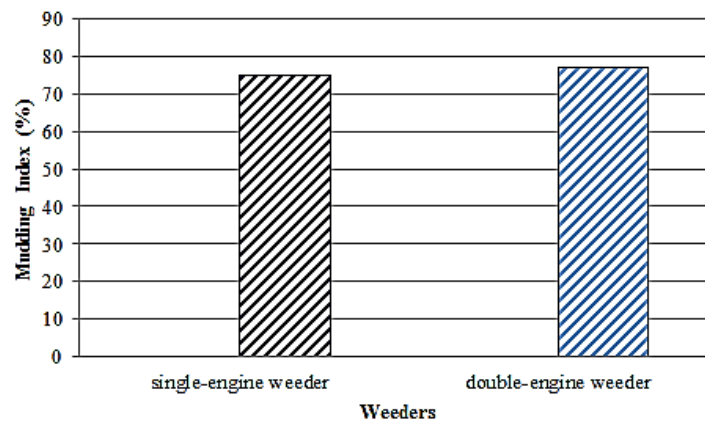

Figure 8. The mudding index of each weeder

The use of a double power weeder provided the highest mudding index of 77.62% because it was done mechanically so that the sludge formation process was faster and better. The mudding index value close to 100% indicated that the mixing between water and mud improved. In comparison, the mudding percentage level was more than 50%, indicated that the mud value was concentrated, so it was suitable for rice growth [20]. A low percentage of the muds indicated that the soil was still watery, so it was not suitable for rice growth.

The mudding index data analysis was carried out through an independent sample T-test on the SPSS application with a two-way (two-tailed) significance value of  $0.000 < 0.05$ . The results of the Independent Sample T-Test test are shown in Table 7.

Table 7. The results of the independent sample T-test of the mudding index

		The mudding index		
		Equal variances assumed	Equal variances not assumed	
Levene's Test for Equality of Variances	F	0.028		
	Sig.	0.872		
t-test for Equality of Means	T	-0.614	-0.614	
	Df	8	7.995	
	Sig. (2-tailed)	0.556	0.556	
	Mean Difference	-2.356	-2.356	
	Std. Error Difference	-11.208	-11.208	
	95% Confidence Interval of the Difference	Lower	-11.208	-11.209
		Upper	6.496	6.497

Based on Table 7, there was no significant difference between the value of the mudding index on the single power weeder and the double power weeder. It was evident from the significant two-way (two-tailed) value of 0.556, where both values were more significant than the alpha value of 0.05.

#### 4. Conclusion

The study results obtained that a single-row weeder implementation is more superior on the parameters of effective working capacity, weeding efficiency, fuel consumption, weeding success rate, the low damaged of rice plants. The advantages of implementing a multi-row weeder (twin-engine) in paddy fields are the theoretical working capacity parameters, effective working capacity, and the mudding index. The performance testing values in the single-row (single-engine) and multi-row (twin-engine) weeding implementations respectively includes the theoretical working capacity of 0.037 ha/hour and 0.054 ha/hour, the effective working capacity of 11.11 minutes and 9.78 minutes, the weeding performance efficiency of 82.48% and 64.87%, the fuel consumptions of 1.07 liters/hour and 1.92 liters/ hour, a weeding success rate of 64.41% and 59.77%, the mudding index values of 75.26% and 77.62%. The calculation results of crop damage rate are 15 and 31 plants.

#### 5. Acknowledgment

All authors would like to thank the University of Lampung, which has supported the implementation of this research.

## 6. References

- [1] Lailiyah, W.N., Widaryanto, E., Wicaksono, K.P. 2014. Pengaruh Periode Penyiangan Gulma Terhadap Pertumbuhan dan Hasil Tanaman Kacang Panjang (*Vigna sesquipedalis* L.) Jurnal Produksi Tanaman, 2 (7), 606-612.
- [2] Aldillah, R. 2016. Agricultural Mechanization and its Implications for Food and Production Acceleration in Indonesia. Forum Penelitian dan Agro Ekonomi 34 (2), 163-177.
- [3] Hantoro, F.R.P., Prasetyo, E., Hermawan, A. 2020. The Impact of Utilizations of Agricultural Equipment and Machinery and Rice Production in Tegal Regency. Pangan, 29, (3), 171-180.
- [4] Widiyawati, S., Tama, I.P., Sugiono, dan Tantrika, C.F.M. 2017. Perbandingan tingkat keberhasilan penyiangan tanaman padi berdasarkan hasil modifikasi Power Weeder Tipe MC1R. Journal of Industrial Engineering Management. 2(1) 36 - 40.
- [5] Pithantomo, B. 2007. Modifikasi dan uji fungsional penyiang bermotor (power weeder) tipe pisau cakar untuk tanaman padi sawah. (Skripsi). Institut Pertanian Bogor. Bogor. 65 hlm.
- [6] Harnel dan Buharman. 2011. Kajian teknis dan ekonomis mesin penyiang (power weeder) padi di lahan sawah tadah hujan. Jurnal Pengkajian dan Pengembangan Teknologi Pertanian. 14(1): 1 – 10.
- [7] Wijaya, A.K. dan Kasda. 2018. Perancangan dan pengujian sistem penggerak penyiang gulma. Jurnal MESA. 3(1): 23 - 31.
- [8] Prabawa, S. 2009. Analisis kebisingan dan getaran mekanis pada traktor tangan. Agritech. 29(2):103 - 107.
- [9] Marfuah, H.H. 2018. Perbaikan Sistem Kerja yang Ergonomis untuk Mengurangi Kelelahan dan Keluhan Muskuloskeletal dengan Pendekatan Ergonomi Partisipatori. Dinamika Teknik. 9(1): 1 - 8.
- [10] Suryaningsih, Y. dan Surjadi, E. 2018. Upaya pengendalian gulma tanaman padi berbasis teknologi pada kelompok tani desa semiring. Jurnal Pengabdian. 2(1): 69-76.
- [11] Telaumbanua, M., Triyono, S., Haryanto, A and Wisnu, F.K. 2019. Controlled Electrical Conductivity (Ec) of Tofu Wastewater as a Hydroponic Nutrition. Procedia Environmental Science, Engineering and Management. 6 (3) 452-463.
- [12] Telaumbanua, M., Haryanto, A., Wisnu, F.K., Lanya, B. and Wiratama, W. 2021. Design of Insect Trap Automatic Control System For Cacao Plants. Procedia Environmental Science, Engineering and Management. 8 (1) 167-175.
- [13] Haryanto, A., Saputra, T.W., Telaumbanua, M., Gita, A.C. 2020. Application of artificial neural network to predict biodiesel yield from waste frying oil transesterification. Indonesian Journal of Science & Technology 5 (1) (2020) 62-74.
- [14] Purbowaskito, W and Telaumbanua, M. 2019. Simulation Study of Kalman-Bucy filter Based Optimal Yaw Rate Control System for Autonomous Tractor. The 3rd International Symposium on Agricultural and Biosystem Engineering. IOP Conf. Series: Earth and Environmental Science 355.
- [15] Santosa, Andasuryani dan Veronica, V. 2005. Kinerja traktor tangan untuk pengolahan tanah. Jurnal Teknologi Pertanian Andalas. 9(2):1 - 7.
- [16] Wijaya, A.K. dan Kasda. 2018. Perancangan dan pengujian sistem penggerak penyiang gulma. Jurnal MESA. 3(1): 23 - 31.
- [17] Harnel dan Buharman. 2011. Kajian teknis dan ekonomis mesin penyiang (power weeder) padi di lahan sawah tadah hujan. Jurnal Pengkajian dan Pengembangan Teknologi Pertanian. 14(1): 1 – 10.
- [18] Pramuhadi, G., Daywin, F.J., Mandang, T., dan Haridjaja, O. 1999. Studi optimasi rasio kecepatan linier pisau rotari dan kecepatan maju traktor pada pelumpuran tanah padl sawah. Buletin Keteknikan Pertanian. 13(3):40 – 56.

- [19] Sulistyosari, N. 2010. Kajian Pemilihan Alternatif Penyiangan Gulma Padi Sawah. (Skripsi). Institut Pertanian Bogor. Bogor. 118 hlm.
- [20] Karimah, N., Sugandi, W.K., Thoriq, A., Yusuf, A. 2020. Analisis Efisiensi Kinerja pada Aktivitas Pengolahan Tanah Sawah secara Manual dan Mekanis. Jurnal Keteknikaan Pertanian Tropis dan Biosistem. 8(1):1 – 13.



## ● 18% Overall Similarity

Top sources found in the following databases:

- 16% Internet database
- Crossref database
- 15% Submitted Works database
- 16% Publications database
- Crossref Posted Content database

### TOP SOURCES

The sources with the highest number of matches within the submission. Overlapping sources will not be displayed.

1	<b>coursehero.com</b>	Internet	4%
2	<b>e-sciencecentral.org</b>	Internet	2%
3	<b>Udayana University on 2022-01-05</b>	Submitted works	1%
4	<b>vuir.vu.edu.au</b>	Internet	<1%
5	<b>"Explore Business, Technology Opportunities and Challenges After the...</b>	Crossref	<1%
6	<b>Smith, BaShaun H. L.. "Emotional Support Animals:", Western Carolina ...</b>	Publication	<1%
7	<b>old.rrjournals.com</b>	Internet	<1%
8	<b>The Robert Gordon University on 2014-08-23</b>	Submitted works	<1%

9	<b>ujoimro.com</b>	Internet	<1%
10	<b>zombiedoc.com</b>	Internet	<1%
11	<b>Vels University on 2017-12-04</b>	Submitted works	<1%
12	<b>Walden University on 2011-08-21</b>	Submitted works	<1%
13	<b>automatika.etf.bg.ac.yu</b>	Internet	<1%
14	<b>Cardiff University on 2019-08-28</b>	Submitted works	<1%
15	<b>Namratha Makanapura, C Sujatha, Prakash R Patil, Padmashree Desai. ...</b>	Crossref	<1%
16	<b>backend.orbit.dtu.dk</b>	Internet	<1%
17	<b>brieflands.com</b>	Internet	<1%
18	<b>www-personal.umich.edu</b>	Internet	<1%
19	<b>M Telaumbanua, E A Savitri, A B Shofi, S Suharyatun, F K Wisnu, A Hary...</b>	Crossref	<1%
20	<b>S Isaev, A Leontiev, O Milman, D Nikushchenko, A Egorova. "Energy-effi...</b>	Crossref	<1%

- 21 **journal.suit.edu.pk** <1%  
Internet
- 
- 22 **ouci.dntb.gov.ua** <1%  
Internet
- 
- 23 **Qi Guo, Meng Wu, Guangning Pu, Kun Guo. "Analysis of Behaviour for B...** <1%  
Crossref
- 
- 24 **mjltn.org** <1%  
Internet
- 
- 25 **01s.nomor.net** <1%  
Internet
- 
- 26 **O Hildayani, R E Putri, Andasuryani. "Development of "Wheel Hoe" App...** <1%  
Crossref
- 
- 27 **The French - Vietnamese Center for Management Education on 2020-0...** <1%  
Submitted works
- 
- 28 **digital.library.unt.edu** <1%  
Internet
- 
- 29 **A Cahyani, J Kurniasari, R Nafingah, S Rahayoe, E Harmayani, A D Sapu...** <1%  
Crossref

## ● Excluded from Similarity Report

- Bibliographic material
- Manually excluded sources
- Quoted material

### EXCLUDED SOURCES

<b>M Telaumbanua, Witaningsih, B Lanya, A Haryanto, S Suharyatun, F K Wisnu. ...</b>	<b>85%</b>
Crossref	
<b>researchgate.net</b>	<b>13%</b>
Internet	
<b>iopscience.iop.org</b>	<b>8%</b>
Internet	
<b>repository.lppm.unila.ac.id</b>	<b>7%</b>
Internet	
<b>H Pratomo, A N Ichniarsyah, T P Purboningtyas. "Design of 'ready-to-pack' de...</b>	<b>7%</b>
Crossref	
<b>M Q Aringo, C G Martinez, O G Martinez, V B Ella. "Development of Low-cost S...</b>	<b>7%</b>
Crossref	
<b>R C Ramirez, E S Agulto, S D Glaser, Z Zhang, J A C Hermocilla, V B Ella. "Deve...</b>	<b>7%</b>
Crossref	
<b>Immanuel Lamma Wabang, Paulus Edison Plaimo, Andri Hendrizal, Isak Feridiks...</b>	<b>7%</b>
Crossref	
<b>A Alfarisi, T Mandang, A Sutejo. "Characteristics of Oil Palm Stem Mulch as S...</b>	<b>7%</b>
Crossref	
<b>N A P Panaligan, M Q Aringo, V B Ella. "Assessment of potential for adoption ...</b>	<b>7%</b>
Crossref	

<b>B D A Nugroho, C Arif, F Suryandika, U Hapsari, B Nihayah, Muslihin. "The Effe...</b>	<b>7%</b>
Crossref	
<b>A B Llaban, V B Ella. "Conventional and sensor-based streamflow data acquisi...</b>	<b>7%</b>
Crossref	
<b>researchrepository.murdoch.edu.au</b>	<b>7%</b>
Internet	
<b>M Telaumbanua, F R Azwar, B Lanya, A Haryanto, E R Amien. "Design of Auto...</b>	<b>6%</b>
Crossref	
<b>I V Fetyukhin, A S Popov, V V Tolpinskii. "Weed control in the cultivation of cor...</b>	<b>6%</b>
Crossref	
<b>dspace.jgu.edu.in:8080</b>	<b>6%</b>
Internet	
<b>repository.upiypk.ac.id</b>	<b>6%</b>
Internet	
<b>umpir.ump.edu.my</b>	<b>6%</b>
Internet	
<b>istina.ipmnet.ru</b>	<b>6%</b>
Internet	
<b>eprints.upnyk.ac.id</b>	<b>6%</b>
Internet	
<b>Weng Cheong Tan, Lip Huat Saw, Ming Chian Yew, Kuo Pei-Yu, Zheng Yu Khor...</b>	<b>6%</b>
Crossref	
<b>Hayder Bahjat Nasih, Harith B. Abdulrahman, J. Z. Ghassan. "Effect of Agricult...</b>	<b>6%</b>
Crossref	

<b>A F Amalia, H S P Rahayu, Risna, Syafruddin. "Performance of Jarwo Rice Tr...</b>	<b>6%</b>
Crossref	
<b>Saja Nadhim Hussein, Jawad Abdul Kadhim Kamal. "Effect of Rhizobium Legu...</b>	<b>6%</b>
Crossref	
<b>repository.uhamka.ac.id</b>	<b>6%</b>
Internet	
<b>repository.tudelft.nl</b>	<b>6%</b>
Internet	
<b>eprints.uthm.edu.my</b>	<b>6%</b>
Internet	
<b>centaur.reading.ac.uk</b>	<b>6%</b>
Internet	
<b>Pennsylvania College of Technology on 2022-09-06</b>	<b>5%</b>
Submitted works	
<b>eprints.utm.my</b>	<b>5%</b>
Internet	
<b>dspace.bsu.edu.ru</b>	<b>5%</b>
Internet	