

PAPER • OPEN ACCESS

Measurement of Physical Parameters of Water Quality in Real-Time Based on Arduino

To cite this article: Junaidi *et al* 2021 *J. Phys.: Conf. Ser.* **1751** 012067

View the [article online](#) for updates and enhancements.



IOP | ebooks™

Bringing together innovative digital publishing with leading authors from the global scientific community.

Start exploring the collection—download the first chapter of every title for free.

Measurement of Physical Parameters of Water Quality in Real-Time Based on Arduino

Junaidi*, T M Putra, A Surtono, G A Puazi, S W Suciwati, I Firdaus and L Rumiyantri

Department of Physics, Faculty of Mathematics and Natural Sciences, Universitas Lampung, Bandar Lampung-Indonesia 35145

E-mail: junaidi.1982@fmipa.unila.ac.id

Abstract. In this study, a physical parameter measurement system has been implemented for real-time monitoring of Arduino-based water quality for catfish farming applications. This system aims to detect physical parameters of water quality such as pH and water temperature using the Analog pH Meter and DS18B20 sensors. Data were collected by inserting the two sensor probes into the catfish pond water medium. The results showed that the system can detect parameters, display and store sampling data on the Visual Studio 2013 interface application in real-time. The sensors in this system are able to detect pH and water temperature with an average accuracy rate of 90.94% and 99.71%.

1. Introduction

Nowadays, technological innovations are still being carried out for the measurement and monitoring process based on wireless networks. Wireless networking refers to the use of embedded communications technology to physical objects that allow these objects to be controlled via remote communications such as bluetooth. Bluetooth communication can be used as a medium for sending water quality parameter data in catfish aquaculture ponds.

The quality of pond water where catfish farming is very important to note. Water with conditions that do not meet the requirements is a source of disease which will be very dangerous for the growth of catfish. The water quality that is considered good for catfish cultivation is at the optimum water temperature in the range of 25 to 30°C [1]. Another parameter that must be considered is the change in hydrogen potential (pH) or the level of acidity and basicity in water. The pH condition for good pool water is 6.5 to 9.0. The condition of pH less than 5 is very bad for catfish, because it can cause clumping of mucus in the gills, while for a pH value above 9 will cause a decrease in appetite for catfish [2]. Therefore, to solve this problem, we need a tool that can monitor and record the water quality parameters of catfish culture in real-time.

Research on the design of pH meter based on Arduino has been done before with several methods, such as Arduino communication technique with Bluetooth, short message service (SMS) gateway, data logger technique on secure card (SD card), and liquid crystal display (LCD) as a character viewer [3-5]. Based on these methods, the communication method using bluetooth, data logger and LCD as a character display makes it possible to design a pH and temperature monitoring system in a simple,



efficient way, and produce a tool that is easy to use when compared to other methods. In addition, the tools and materials needed are relatively cheap and easy to obtain.

Based on this explanation, in this study a water quality monitoring system based on Arduino was built using real-time for catfish farming applications in Buanasakti Village, Batanghari District, East Lampung. The system design that is built includes making software and hardware. The water quality monitoring system software is made using The Arduino Integrated Development Environment (Arduino IDE) and Visual Studio 2013 software. Meanwhile, the system hardware uses components which include a power supply as a DC voltage source, Arduino as a control system, DS18B20 sensor as a water temperature detector, Analog pH sensor meter as a water pH detector, LCD as a data viewer and a bluetooth (HC-05) module as a wireless data transmitter [6-7].

2. Materials and methods

The materials used in the research are analog pH sensor and SEN0169PH module, DS18B20 temperature sensor, HC-05 bluetooth module, 16x2 LCD character, Arduino pro mini, power supply and personal computer (PC). The software used in this research is Arduino IDE 1.8.10 for creating, opening, and editing programs that will be inserted into the Arduino Pro Mini board, Visual Studio 2013 for creating system interface applications with a PC, and Eagle 9.5.0 for creating schematic designs and circuit layout.

Broadly speaking, this research is divided into several stages, namely the design of the instrumentation system, testing, and data collection. In general, the system design to be made is shown in the block diagram in Figure 1.

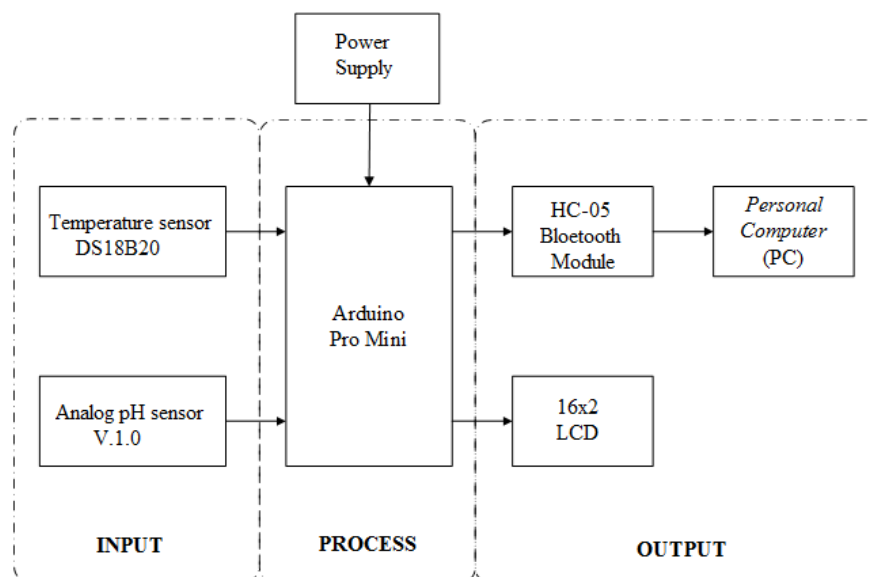

Figure 1. Block diagram of Measurement of Physical Parameters of Water Quality in Real-Time Based on Arduino.

The system design that is built includes parameter reading, processing, sending data in Visual Studio 2013 software and storing data in Microsoft Excel 2016 software. At the parameter reading stage, the sensors read physical parameters and convert them into electrical quantities (analog signals). Analog signals are converted into digital signals using the Arduino Pro Mini processor. The digital value of the conversion results will be displayed on the LCD, then the data will be sent to the interface application in the Visual Studio 2013 software via a wireless network using a bluetooth module and the measurement results will be stored in the Microsoft Excel 2016 software. In addition, the

monitoring instrumentation system circuit scheme is shown in Figure 2.

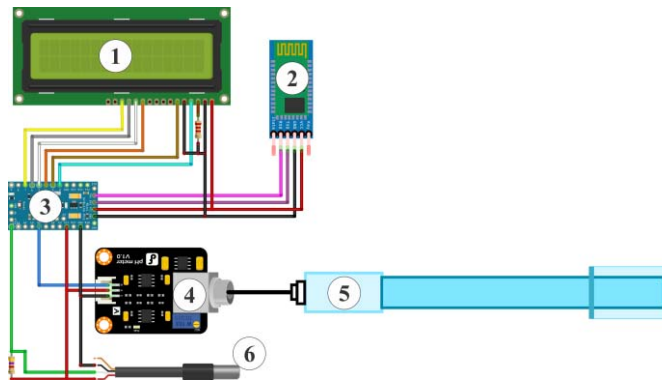

Figure 2. The circuit schematic measurement of physical parameters of water quality in real-time based on Arduino

Figure 2 shows that: (1) 16x2 character LCD, (2) HC-05 bluetooth module, (3) Arduino pro mini, (4) SEN0169PH module, (5) Analog pH sensor, and (6) DS18B20 temperature sensor module. Figure 2 is a schematic of the monitoring instrumentation system circuit. In this system there are 12 Arduino pins that are used along with 2 power pins, namely VCC and GND. The 10 Arduino pins used are pins D0, D1, D2, D3, D4, D5, D6, D7, D10, and A0. Pins D0 and D1 function as serial communication pins (RX and TX) with bluetooth. Pins D2, D3, D4, D5, D6, and D7 are the pins used to communicate between Arduino and 16x2 character LCD. Pin D10 is the pin used to communicate between the Arduino and the DS18B20 sensor. Meanwhile, pin A0 is the pin used for communication between the Arduino and the analog pH module version 1.0.

3. Results and discussion

The water quality monitoring instrumentation system based on Arduino Pro Mini has been realized with the results shown in Figure 3.

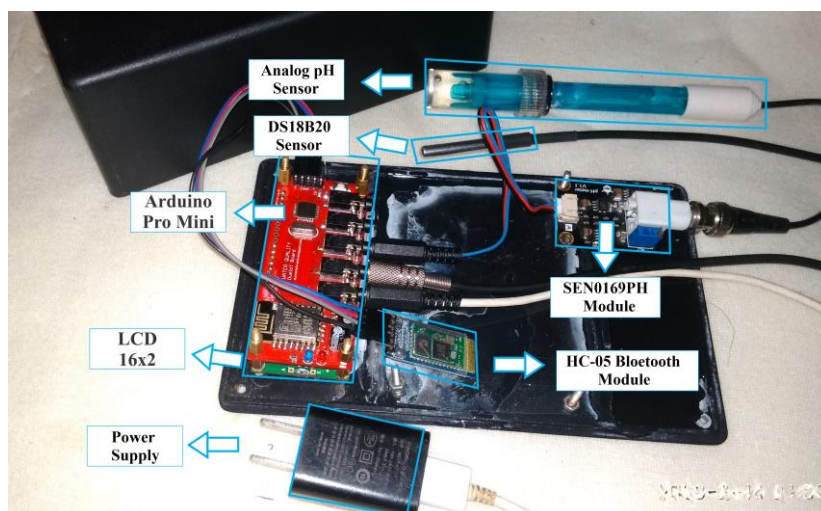

Figure 3. The water quality monitoring instrumentation system based on Arduino Pro Mini

Figure 3 shows that the components in this tool include Arduino Pro Mini, 16x2 character LCD, HC-

05 type bluetooth module, Analog pH sensor Version 1.0, SEN0169PH module, DS18B20 sensor, and 5V 2A power supply. Meanwhile, the box used by this hardware device has dimensions of 18 cm x 11 cm x 6 cm. LCD pins are connected via digital pins, namely D2, D3, D4, D5, D6, and D7 Arduino Pro Min. LCD displays pH and temperature measurement data of water [8].

Analog pH Sensor: PH analog sensors are used to detect the level of acidity (pH) in water. This sensor module is equipped with a pH probe, operational amplifier and analog digital to converter (ADC). Analog pH sensor testing is carried out so that the sensor readings are in accordance with the calibrated instrument reading standards. The working principle of this sensor is found in the reference electrode and the glass electrode, which at the end is round and functions as a place for positive ion exchange (H^+), which causes a potential difference between the two electrodes so that the reading produces positive or negative values (Onny, 2019).

Analog pH sensor testing is carried out using a sample buffer before it is implemented in catfish aquaculture. The pH analog sensor testing process is carried out in a laboratory room with the detected acidity (pH) level on the analog pH sensor compared to the standard buffer sample value. The supporting media used is a sample holder with dimensions of 8 cm x 8 cm x 7 cm. The test mechanism in this study is that the analog pH sensor is placed alternately in the place of the sample which has been previously given buffer liquid as shown in Figure 4.

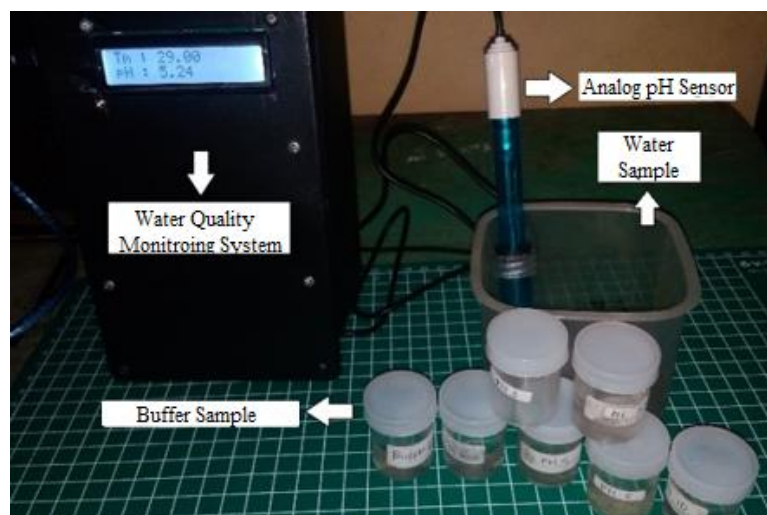

Figure 4. Testing the acidity level of the analog pH sensor with a standard pH solution.

The process of testing the Analog pH sensor is carried out by providing a standard buffer sample ranging from pH 3-10 per one increase in pH value. The test was carried out with 5 repetitions. The repetitions are carried out in the opposite direction where repetitions of 1, 3 and 5 are measured from pH 3 (minimum) to pH 10 (maximum) while repetitions of 2 and 4 are measured from pH 10 (maximum) to pH 3 (minimum). This serves to see deviations that may occur when measurements are made from two opposite directions or this is known as hysteresis. Testing the acidity level (pH) of the Analog pH sensor aims to see the level of accuracy, precision, and error (error) of the system that has been made. The test results can be seen in Figure 5.

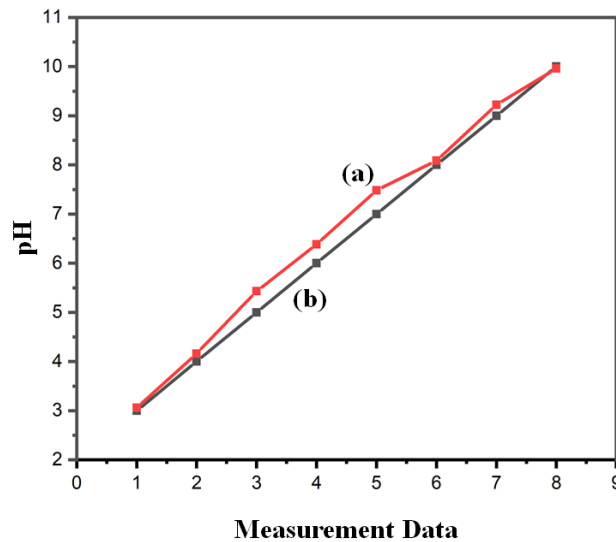

Figure 5. Graph of acidity level (pH) test on (a) Analog pH sensor against and (b) standard buffer sample.

The test results show the linearity (R^2) obtained is 0.99403. R^2 value is the level of conformity of the obtained line equation to data variations with a value range of 0-1. If the value of $-R^2$ approaches 1, the equation of the line obtained is in accordance with the variation of data [5]. In addition, the average value of accuracy and precision obtained from the calculation results were 90.94% and 97.85%, respectively. The higher the resulting accuracy value, the better the performance of the tool and the higher the precision value, the more precise the measurement is [6, 3]. This shows that the Analog pH sensor has a good level of accuracy and precision and can be used to detect acidity levels (pH).

DS18B20 sensor: The temperature testing process of the DS18B20 sensor is carried out by comparing the sensor measurement value against the HTC-2 calibrator. The test was carried out by inserting the DS18B20 and HTC-2 sensor probes into a container filled with hot water with the measured temperature on the HTC-2 display showing the number 60oC. The test data includes a temperature of 20-60oC with an interval of 1oC for each measurement. The temperature test was repeated 5 times. The test results can be seen in Figure 6

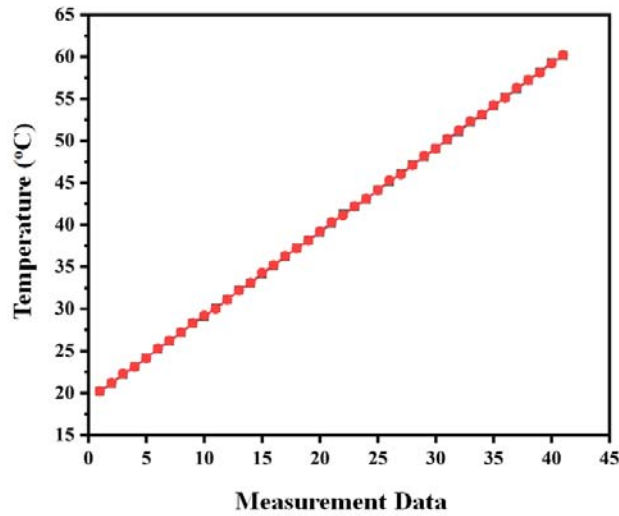

Figure 6. Graph of testing the characteristics of the sensor output voltage (DS18B20) to the standard tempetarute (HTC-2).

The test results show the linearity (R^2) obtained is 0.99996. Meanwhile, the average accuracy and precision values obtained from the calculation were 99.71% and 99.83%. This shows that the DS18B20 sensor has good accuracy and precision in temperature readings.

Baudrate Testing: The HC-05 bluetooth module has a command set to change baudrate, bluetooth name, change password, and other functions. To be able to change the bluetooth baudrate via the main command set which is done by setting the default baudrate to 38400 as bluetooth standard communication. The baudrate provided by the bluetooth HC-05 vendor is as follows: 1200; 2400; 4800; 9600; 19200; 38400; 57600; and 115200 [7].

The first test is to measure the standard buffer (pH buffer) using an Analog pH sensor, then the test data is sent wirelessly to an interface application with baudrate settings at 9600, 38400, and 115200. The baudrate test results are shown in Figure 7.

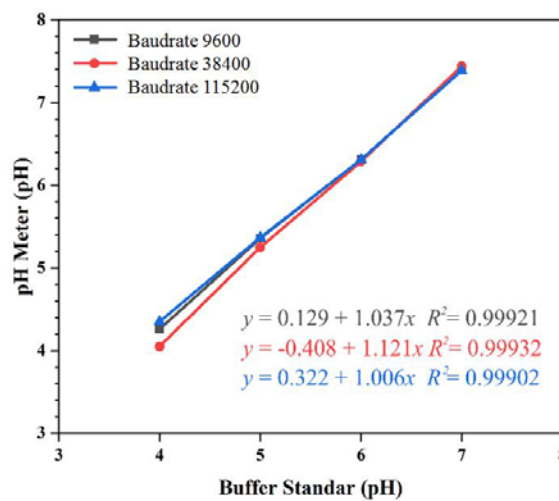

Figure 7. Graph of pH meter testing at baudrate 9600, 38400, and 115200 against standard buffer

Figure 7 shows the linearity (R^2) at 9600 baudrate obtained of 0.99921. The the linearity (R^2) value at 38400 baudrate was obtained at 0.99932. Meanwhile, and the linearity (R^2) at 115200 baudrate was 0.99902 [9, 10].

4. Conclusion

The water quality monitoring instrumentation system based on Arduino Pro Mini using real-time wireless methods for catfish farming applications has been realized and can work well. The readings from both sensors have excellent linearity, accuracy and precision. The calibration of the measurement of the acidity level (pH) has been carried out using a standard buffer sample with a pH scale of 3-10, obtained an average measurement error of 9.06%, so that the average accuracy value of the analog pH sensor is 90.94%. The percentage level of precision of the analog pH sensor from the calculation results obtained an average of 97.85%, so that this analog pH sensor has a good level of precision. Calibration of temperature measurements has been carried out using the HTC-2 calibrator with a temperature measurement scale between 20-60 oC, an average measurement error of 0.29% was obtained, so that the average DS18B20 sensor acquisition value was 99.71%. The percentage level of precision of the DS18B20 sensor from the calculation results obtained an average of 99.83%

5. References

- [1] Virgala I, Michal K, Alexander G, Tomas L 2015 Control of Stepper Motor by Microcontroller. *Journal of Automation and Control* 3(3): 131-134.
- [2] Ingole, M.A.N. 2016. *Arduino based Solar Tracking System. International Conference on Science and Technology for Suistainable Development* ISSN: 2348-8549 pp 61-66.
- [3] Genevra, E.C., Ikechukwu, O.P., Samuel, M.E., Godwill U.N. 2013. An Effective Approach Designing Seven Segment Static Display Systems with Complete Character Representation. *Journal of Engineering and Science* 3(12): 45-49.
- [4] Surya, V., Srutartha, B., Shreya, K., Kathirvelu, D. 2018. Ocular Drug Delivery System Using Open-Source Syringe Pump. *Asian Journal of Pharmaceutical and Clinical Research* 11(6), 152-157.
- [5] Avnimelech, Y. 2007. Feeding With Micobial Flocs by Tilapia in Minimal Discharge Bio-flocs Tecnology Ponds. *Aquaculture*. 264, 140-147.
- [6] Bondarenko, O. K. and Kongsford M. 2007. Under water Sensor Network, Oceanography and Plankton Assemblages. *Jurnal IEEE*. 3(1), 657-662).
- [7] Jones, L.D. and Chin, A.F. 1991. *Electronics Instruments and Measurements*. Upper Saddle River: Prentice-Hall.
- [8] Morris, A.S. 2001. *Measurement and Intrumentation Principles Edition III*. Planta Tree: Inggris.
- [9] Silva, J.F.M.C., Santos, D. M. S., Marques, V. C., Oliveira, K. D, Rodrigues, T. O., Texeira, R. G. F., Menezes, J. W. M., and Silva, F. D. 2012. A Study of Bluetooth Application for Remote Controlling of Mobile Embedded System. *Journal Computing System Engineering*. Brazilian Symposium on. 116.
- [10] Van, W. and Scarpa J. 1999. *Water Quality Requirements and Management*. Farming Marine Shrimp in Recirculating Freshwater System.

Acknowledgment

Acknowledgments to research institutes and community service, Universitas Lampung by supported a profeshorship research grant, Contract No. 1516/UN26.21/PN/2020”.