

# Sensor Network Systems for Environmental Data Acquisition

Warsito Warsito<sup>\*</sup>, Alfian B L Sinaga<sup>\*</sup>, Sri R Sulistiyanti<sup>†</sup>, Gurum A Pauzi<sup>\*</sup>, and Amir Supriyanto<sup>\*</sup>

<sup>\*</sup>Physics Department, Faculty of Mathematics and Natural Sciences, University Of Lampung, Indonesia

<sup>†</sup>Electrical Department, Faculty of Engineering, University Of Lampung, Indonesia

<sup>\*</sup>Email: warsito@fmipa.unila.ac.id

**Abstract— It has been designed and realized a multi transmitter telemetry system for measuring the temperature and humidity using radio frequency waves. The sensors that used for measuring temperature and humidity is SHT11 and using RF APC220 for data transmission. Main controller for this telemetry data acquisition system is ATmega 128 microcontroller. The output of the measurement results also displayed on LCD and stored in a micro SD. The obtained resolution of temperature sensor is 0.1°C and humidity sensor is 0.1%.**

## I. INTRODUCTION

Humidity is vapor concentration in air. This concentration number can be expressed into absolute humidity, specific humidity or relative humidity. Humidity, it is one of important factor for live creature. Humidity also can influence how live creature can adapt with their environment.

One of factor that can influence humidity is temperature. Temperature and humidity was one of important factor for physics, chemistry and biology. By growth of sensor and transducer on electrical so there are many digital measurer invented to make easier for temperature and humidity measuring.

The common sensor used for temperature and humidity measuring is capacitive sensor, because cheap and specific detecting numbers in humidity [1]. For temperature and humidity measuring equally use one module can use SHT 11 [2]. There are no differences measure with SHT 11 and other measuring tools [3]. SHT 11 also already used for measure temperature and humidity at granary [4], alarm system at storehouse [5], and temperature and humidity control at green house [6].

In implementation, it will be difficult to know an exact result from measuring instrumentation that have made because area that will be measure is mountains, forest, a plantation area, or flowing water area so required other instrumentation for help watch measuring result. To simplify this technical problem, we can employ wireless technology using radio frequency system, GSM network or internet system. Long distance temperature and humidity measuring monitor have been done that is using internet network based on java [7], using android application [6], using GSM network [8], telemetry using radio frequency wave also have

been carried out that is using NRF24L01 [9] and using radio network [4, 10 - 15].

Based on that research, it can be made realization temperature and humidity measure system using SHT 11 sensor and radio module RF APC 220 that consisted of transmitter and receiver as data sender and data measure result receiver and using AT-Mega 128 microcontroller as main controller.

## II. METHOD

For designing in temperature and humidity system divided in two parts, that is hardware and software. Hardware block diagram from this research can be seen on Fig. 1.

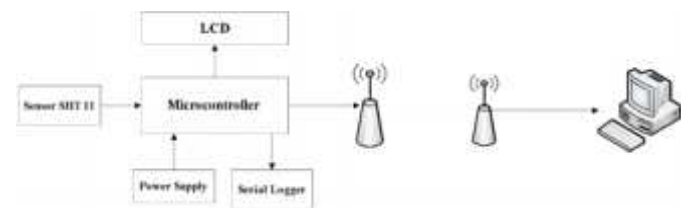

Fig. 1 Hardware Block Diagram

From hardware can be seen in this research use SHT 11 sensor as temperature and humidity detection sensor, Microcontroller as main control use ATmega 128.

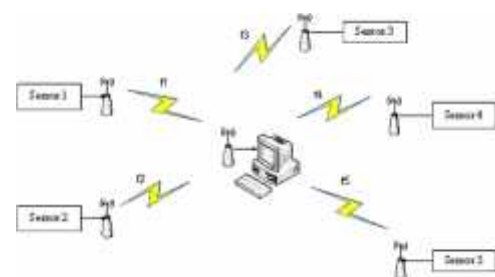

Fig. 2 Data Transmission Block Diagram

To control timer, we use RTC (real time clock). Measure result data that received from SHT 11 is a having digital form that process by microcontroller so data can be sent by radio module RF APC 220, in addition measure result also displayed on LCD and using recording module serial logger data can be stored in micro-SD. After data received by RF APC 220 receiver modules so data can be displayed on PC by using RF Magic software.

For software designing, we used BascomAVR software. In this research data transmission system using radio waves that is using RF APC 220 module. Telemetry system for temperature and humidity transmission system block diagram can be seen in Fig. 2. This system will be work when the power supply on. So LCD that has been already turned on will on and calibration result from the sensor will showed.

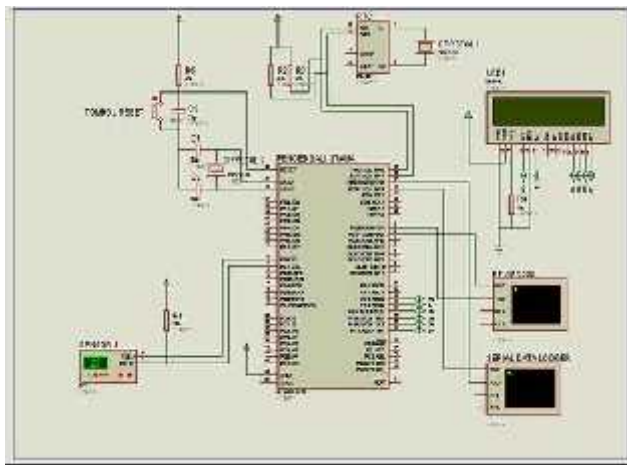

Fig. 3 Hardware Circuit.

Sensor that used in this instrument uses 5 V dc power supply and bidirectional 2 wire communications system. The realized circuit has been shown in Fig. 3. Temperature and humidity measure technically equal, the differences is in byte value within measure. For temperature measurement, we use “0000011” digital code and for humidity measurement, we use “0000101” digital code.

### III. RESULT AND DISCUSSION

In this research for sensor testing is calibrated temperature and humidity measure. Calibration is done in comparing SHT 11 measuring result with thermometer and digital hygrometer measuring result. This comparison value can be seen in Fig. 4 and Fig. 5. From Fig. 4, we obtained mathematics function  $y = 0.798x + 5.483$  with linear coefficient  $R^2 = 0.990$ , this value shows the difference characteristic between thermometer and SHT 11 sensor. The Fig. 5 shows the mathematics function  $y = 0.946x + 7.058$  with linear coefficient  $R^2 = 0.989$ , this value shows the difference characteristic between digital hygrometer and SHT 11 sensor.

The response of realized sensor will be employed as the equation recorded in the microcontroller. It will give us the simple method to adjust SHT 11 sensor value with thermometer and digital hygrometer value, so the value of temperature and humidity that obtained from telemetry system have been calibrated.

For whole instrument testing undertaken in Bandar Lampung, Indonesia. This measuring was done at November 5- 6, 2016 at 9.00 WIB to 2.00 WIB. This measuring value can be seen at Fig. 6 and Fig. 7.

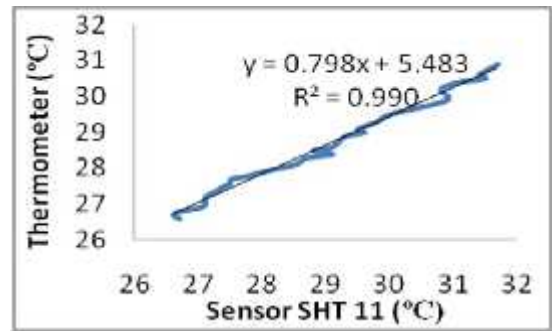

Fig. 4 Comparison between Thermometer and SHT 11 value.

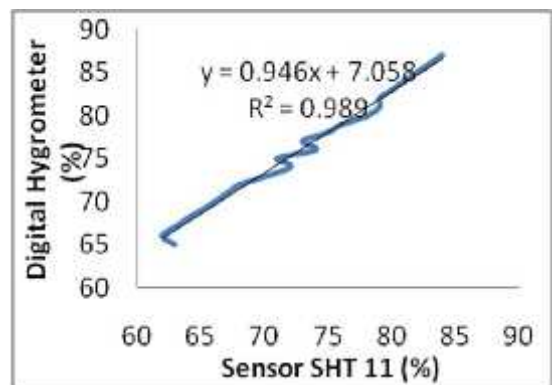

Fig. 5 Comparison between Hygrometer and SHT 11 value.

From Fig. 6 and Fig. 7 can be seen that if temperature value higher so relative humidity will be lower. At night where temperature lower and there is no sun radiation to heat up earth made vapor in air is easier to saturate. As a consequence in that condition humidity value becomes higher.

Radio frequency is used to data transmission from measure system to personal computer (PC). In this research use two condition testing there are line of sight condition and non-line of sight condition. Line of sight condition testing, in this test there is no obstacle between transmitter and receiver.

In this line of sight testing that have done show that RF APC220 can transmitted data at  $\pm 5$  M,  $\pm 40$  M,  $\pm 100$  M and

±190 M, when testing done at point more than 190 M, RF APC can't get data.

Non line of sight condition is there is obstacle between transmitter and receiver and carried out with two different points. In this non line of sight testing RF APC 220 can transmitted data at ±5 M, ±40 M, ±80 M, ±100 M. when testing done at point more than 120 M, RF APC can't get data.

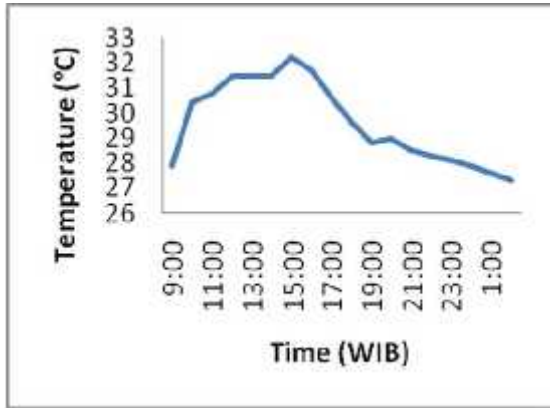

Fig. 6 Temperature and Time Conjunction Graph.

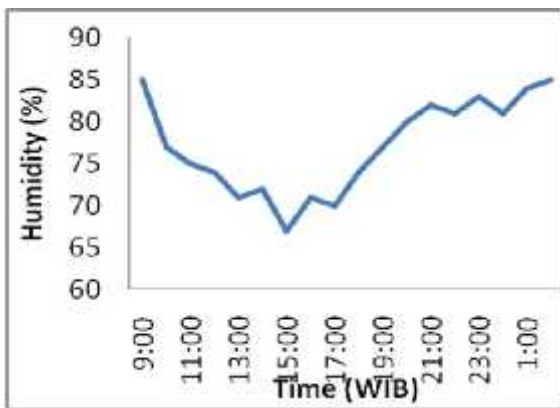

Fig. 7 Humidity and Time Conjunction Graph.

In this research, was designed a telemetry system for temperature and humidity measuring using 5 sensors and 5 transmitter.

Frequency than can be broadcasted by RF APC220 module are from 418 MHz up to 455 MHz so to make easier in this measuring system so each system are given personal frequency values.

Each transmitter has its own frequency value that have been determined, that are:

- Transmitter 1 with frequency 433 MHz
- Transmitter 2 with frequency 440 MHz
- Transmitter 3 with frequency 445 MHz
- Transmitter 4 with frequency 450 MHz

Transmitter 5 with frequency 455 MHz

To see measuring results from sensor 1 so carried out by settle frequency value at RF Magic program by insert frequency value that has determined and the result will be shown in Termite program.

In this research, the designed program to make easier frequency adjustment at RF Magic as shown in Fig. 9. In this program if selected value that will open, for example 1, so the computer will open RF Magic program with frequency value adjustment 433 MHz and user select write point at RF Magic and then close RF magic program, after that data that transmitted by sensor 1 using radio waves with frequency 433 MHz will be displayed on termite program.

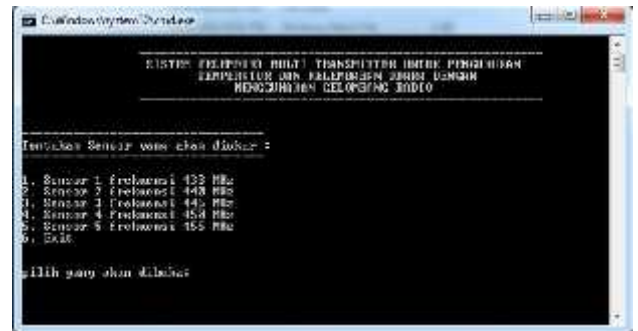

Fig. 9 Frequency Adjustment Appearance.

#### IV. CONCLUSIONS

After SHT 11 sensor calibration so obtained regression value for temperature measuring is 0.990 and for humidity measuring is 0.989. If temperature higher so relative humidity value become lower and in the night its easier become saturated against vapor so make Rh become high. Maximum distance using RF APC220 module in line of sight condition is 190 meters and non line of sight condition is 110 meters.

#### ACKNOWLEDGMENT

The authors thank the Directorate General of Higher Education, Ministries of Research, Technology, and Higher Education Republic of Indonesia which has given financial support to this research.

#### REFERENCES

- [1] Wagner, T., Soren, K., Alexander, W., Tilman, S. Claus, D., Jan, R., Michael, T. (2011). A High Temperature Capacitive Humidity Sensor Based on Mesoporous Silica. *Sensors* 2011, 11:3135-3144.
- [2] Cretu, G. (2008). Using of Humidity Sensors in MeasuringSystem. Actual Tendencies and Problems. *9th*

*International Conference On Development And Application Systems*, Suceava, Romania, May 22-24 pp 5-8.

- [3] Talapessy, R. (2013). Purwarupa Alat Kontrol Suhu Dan Kelembaban. *Prosiding FMIPA Universitas Pattimura 2013* pp 48-53.
- [4] Dong, J., Huile, L., Yuan, L., Yanwen, G., Guanhua, T. (2014). Design of a Wireless Monitoring Network for Granary Temperature and Humidity Based on Zigbee. *International Journal of u- and e- Service, Science and Technology* Vol.7, No.2 (2014), pp.77-82.
- [5] Lin, J., Zhao T. (2013). Granary Temperature And Humidity Detection System Based On MCU. *Advanced Materials Research* Vols 605-607 (2013) pp 941-944.
- [6] Hanggoro, A., Mahesa, A., Rizki, R., Riri, F. (2013). Green House Monitoring and Controlling Using Android Mobile Application. *IEEE Quality in Research 2013* pp 79-85.
- [7] Sugiarti, E., Adhi, H. (2011). Monitoring Kelembaban dan Temperatur Melalui Sistem Java Remote Laboratory Berbasis Internet. *TELAAH Jurnal Ilmu Pengetahuan dan Teknologi* Volume 29 (2) 2011: 47-54.
- [8] Alpaslan, A. (2012). Remote Control of the Temperature-Humidity and Climate in the Beehives with Solar-Powered Thermoelectric System. *CEAI*, Vol.14, No.1, pp. 93-99.
- [9] Gang, J., Fan, W., He, P., Liu, Y., (2013). Design of Multi-point Wireless Temperature and Humidity Sensor Network Based NRF24L01. *Information Technology Journal* 12 (20): 5812-5817.
- [10] Salleh, A., M. K. Ismail, N.R Mohamad, M.Z.A.Abd.Aziz, M.A.Othman, M.H. Misran. (2013). Development of Greenhouse Monitoring using Wireless Sensor Network through ZigBee Technology. *International Journal of Engineering Science Invention* ISSN (Online): 2319 – 6734, ISSN (Print): 2319 – 6726 Volume 2, Issue 7 July. 2013 pp. 06-12.
- [11] Kaushik, S., Singh, C. (2013). Monitoring and Controlling in Food Storage System using Wireless Sensor Networks Based on Zigbee & Bluetooth Modules. *International Journal of Multidisciplinary in Cryptology and Information Security* Volume 2, No.3, May – June.
- [12] Kumar, H., Manjunath, I. (2012). The Design of Granary Environmental Monitoring and Control System Based On ARM9 and ZIGBEE. *International Journal of Innovative Technology and Exploring Engineering (IJITEE)* ISSN: 2278-3075, Volume-1, Issue-3, August.
- [13] Moorthy, G K., Yaashuwanth, C., Venkatesh, K. (2013). A Wireless Remote Monitoring Of Agriculture Using Zigbee. *International Journal of Engineering and Innovative Technology (IJEIT)* Volume 2, Issue 8, February.
- [14] Ma, R.H., Yu, H, W., Chia, Y, L. (2011). Wireless Remote Weather Monitoring System Based on MEMS Technologies. *Sensors* 2011, 11, 2715-2727.
- [15] Chen, M, K., Wen, B, L., Jiang, M.K. (2014). Remote Multi-layer Soil Temperature Monitoring System Based on GPRS. *Sensors & Transducers*, Vol. 164, Issue 2, February 2014, pp. 107-113.