

## Smart Monitoring Data Centre base on Mini Single Board Computer BCM 2835

Dikpride Despa<sup>1,a</sup>, Mardiana<sup>1,b</sup>, Gigih Forda Nama<sup>1,c</sup>

<sup>1</sup>Department of Electrical Engineering, University of Lampung Jl. Prof.  
Sumantri Brojonegoro No. 1 Bandar Lampung 35145

<sup>a</sup>despa@eng.unila.ac.id, <sup>b</sup>mardiana@eng.unila.ac.id, <sup>c</sup>gigih@eng.unila.ac.id

**Abstract.** Folded plate structures should be redefined as form-resistant structures in which the folded-plate action is a combination of transverse and longitudinal beam action[1] p.296. The early generation of folded plate structure is marked with true folded plate structures. As the number and the variety of building form increases, classification based on form took place and being developed. This leads to confusion. The confusion is shown from building examples. Roofing with either steel or pre-stressed concrete trusses were classified as folded structures. Origami could lead to another confusion, because it could be applied as either a building structure or as a non-structural member, such as ceilings. Based on the case of Sydney Opera House, and on other misleading folded structure building examples, a conclusion to stop the usage of the term “folded structures” has been recommended. Another recommendation is to separate building form categories from building structure classification.

**Keywords:** *Architecture, Building Structure, Construction, Folded Plate Structure, Form-resistant Structures.*

### I. Introduction

University of Lampung (Unila) has 31.000 students, 1300 lecturers and 645 academic staff that used the internet daily. UPT TIK should provide internet services. It has Network Operation Centre (NOC), consists of several servers and network devices. The entire network infrastructure is managed by Divisi Infrastruktur with only 4 administrators. Unila is also facing on electricity problem. Located in the Southern of Sumatera Island Indonesia, some times the blackouts happens. Data center manager’s must be able to provide excellent services to customers in electricity and internet connection. Electrical and internet problems must be maintained properly, and its quality must be monitored any time in order to carry out preventive and corrective measures in the event of disruption or unconditional incident.

This study makes an online system to monitor electrical quantities, temperature and bandwidth in data centers building, so the manager is able to take desicion against these conditions.

Mini single board computer Broadcom BCM2835 SoC, ARM11767JZF-S 700 MHz processor (Raspberry Pi model B) is a major component used in this study. Raspberry Pi serves as an interface to get the data of electrical quantities, temperature and bandwidth as well as save data.

### II. Procedure

#### 2.1. Smart Monitoring System

The Internet of Things (IoTs) can be described as connections of devices such as smart phone, personal computer, sensor, and actuator through to internet network, connected devices could produce information that can be used by human being or other systems [9]. The concept of smart monitoring enables the users to connect, control, and monitoring the system directly over the internet.

The next-generation monitoring should give the information required by users, information must be compact with SMART concept specific, measurable, achievable, relevant, time-bound [17].

## 2.2. Electrical Quantities

Electrical Voltage is the amount of work required to move an electrical charge from one point to another, while the electric current is defined as the amount of charge that flows due to the flow of electrons per unit time. Electrical Power is the amount of electric power that flows per unit time, calculated in units of joules /second or watts by using the following equation [6]:

$$P = VI$$

where :  
 P = Power (Watt or W)  
 V = Voltage (Volt or V)  
 I = Current (Ampere or A)

The theory above is for power systems of direct current, whereas the electric power system of alternating current, the power can be divided into three types, namely: the real power that the electric power used load or electrical equipment to do the work, this power is the product of voltage, current and power factor ( $\cos \phi$ ), apparent power is the product of voltage and current, while the reactive power is the power that is used to generate mechanical power and heat, this power is the product of voltage, current and power factor ( $\sin \phi$ ). Phase angle  $\phi$  greatly influenced by the type of load is attached, if the load is resistive then the current will same phase with voltage ( $\phi = 0$ ), if the load is inductive phase currents will be left behind (lagging) of the phase voltage of  $90^\circ$  ( $\phi = 90^\circ$ ), while if the load is capacitive current phase will go ahead (leading) of the phase voltage of  $90^\circ$  ( $\phi = 90^\circ$ ). However, generally load is a combination of all three types of load, so that the current and voltage have a phase angle difference of  $\phi$ , so the power factor is  $\cos \phi$ .

## 2.3. Room Temperature

Data centers building has servers that should be online for 24 hours potentially produces a heat temperature in the room. If the heat is excessive, it can causes the server to damage. Therefore the rooms must always be kept in accordance with the allowed standard conditions. According to the Cisco standardization temperature, the ideal temperature in data center room is at least  $18^\circ\text{C}$  and  $27^\circ\text{C}$  maximum [2].

## 2.4. Bandwidth

Bandwidth is often used as a synonym for data transfer rate, which is the amount of data that can be taken from a point to another within a certain period (generally within seconds). Bandwidth is usually measured in bps (bits per second). In general, the connection with large bandwidth/high capacity will be capable to deliver of large information. There are several terms associated with a bandwidth that is:

### A. Bandwidth Monitoring System

Simple Network Management Protocol (SNMP) is a protocol with basic methods for controlling the TCP/IP network or network device. SNMP is designed to provide network management services, so that users can maintain and systematically monitor the computer network remotely.

### B. Internet Control Message Protocol (ICMP)

ICMP is a network layer protocol that is used to report success or failure in the delivery of data. This can be indicated as part of a dense network, when data fails to be sent to the destination, and when data is deleted due to the allocation of time when delivery has been exhausted. ICMP announce the failure of the transmission to the sender, but ICMP cannot correct any of a transmission failure.

### C. Packet Internet Groper (PING)

PING is a utility that can verify the TCP / IP installed, connecting to the NIC, configuration checking, and communication with the network. It is often used in TCP / IP configuration or there is something wrong with network connectivity.

### 2.5. Raspberry Pi

Raspberry Pi is an embedded computer that was developed by the Raspberry Pi Foundation, which has a function similar to the PC (Personal Computer) in general. Mini Computer model has two types, namely type A and type B. The difference among them is in memory, the number of USB ports, and network adapter. Raspberry Pi comes with the General Purpose Input/output (GPIO) pins that each of its can be set as an input or output. Through GPIO, Raspberry can accept various inputs to do the programming. Input can be a wide variety of sensors such as a temperature sensor, light sensor, voltage sensor, etc.



Fig 1. Raspberry Pi GPIO

### 2.6. Related Works

The earlier study used as reference is on [6]. This study has made a prototype device that can monitor the amount of electrical. Unfortunately, the current measurement captured process must cut off the power of the panel and if there is any abnormal event, the risk of damage can be occur on prototype. Therefore this research is developed further by using a sensor that can perform measurements without having to cut off the power from the distribution panel so that in case of an abnormal situation, it will not damage the equipment. Furthermore, previous research on temperature monitoring and termination of the electrical connection has also been done in [7]. This study makes a prototype system that can be monitor the temperature scale in the data center and monitor power conditions. The study on [4][5][18], explains how the online monitoring of the power system by using sample data that is recorded on the PMU are placed at various locations with the same frequency. The studies contributed to monitoring the stability of the voltage and frequency of the power system. Preliminary research on the design of a monitoring system using a Single Board Computer BCM2835 is on [8]. While [1] discuss about a prototype of power flow breaker household scale. This tool is able to cut, connect, and send status is active or not active flow of electric power to the connected load of up to 2.2 Kw. Study on [3] and [13] discuss the monitoring of voltage, current and power by using a microcontroller Atmega 16 as a control system.

Still regarding the control and monitoring of room temperature, the study on [15] describes the server room temperature that must be monitored so not to exceed the limits of tolerance. By monitoring the server room temperature, managers can identify and minimize damage to the server. Research on [16] and [12] related to monitoring network that can be displayed in real time by using web services, while [10] monitoring server by

using SMS (Short Message Services). Another of important previous study is related to the presentation of information and the manufacturing quality and interactive web services as an interface to the results of monitoring can be displayed properly, complete and accurate. The studies related on this were on [11] and [12]. Based on the studies that have been done previously on-line monitoring system for a variety of purposes, using a variety of methods and tools, it is expected to be a valuable experience both in the analysis, design and implementation in the field.

### III. Research Methodology

Fig. 2. show the hardware design architecture of system monitoring, from the diagram show the system used 4 type of sensor that is temperature sensor, voltage sensor, current sensor, and kWh meter that those will connected to main control device BCM 2835 (Raspberry Pi) through the GPIO pin. The current, voltage, power, and temperature data will be saved on to database server in real time, MySQL used as data base server engine.

The gathered data will be proceed by the system and shown as a web page and displayed as a historical chart statistic that can be access by users using web browser.

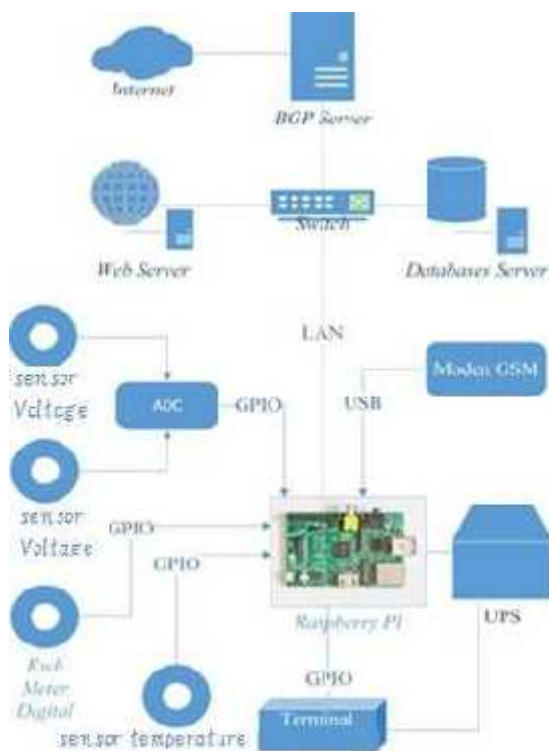
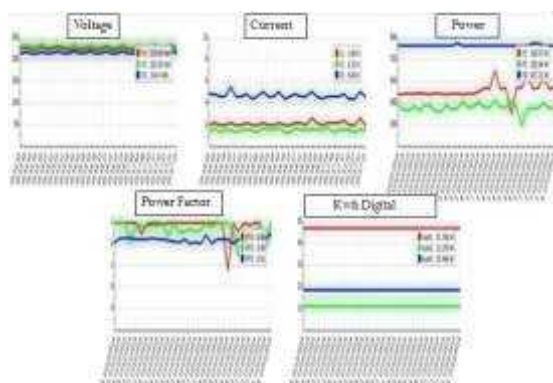

Fig 2. Hardware Design Architecture

## IV. Results and Dsicussions

### 4.1. Development and Implementation

Based on observations and interviews to UPT TIK Manager, the system monitoring should be able to show a real time report and can be accessed through website, system also automatically generates report. Web-based live monitoring created using Python Programming Language, javascript, and html. Data charts graphic should be in realtime and updated every 3 seconds.



(a) Life Web Base Report for Electric Quantities

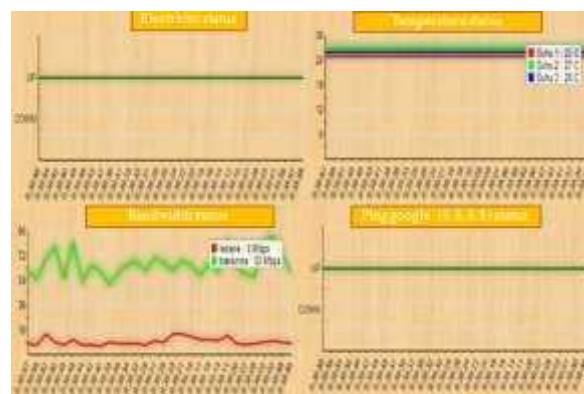

(b) Life Web Base Report for electricity, temperature, network utilization

Fig 3. (a)(b) Application Report

Fig. 3. shows the application report on real time condition, data capture is every 3 second and the system generates the graphics on web application.

### 4.2. Monitoring of Electrical Quantities

The monitoring of Electrical Quantities implementations are displayed in graphical form below. Monitoring charts for each quantities is shown in Fig. 4, Fig. 5, and Fig. 6.

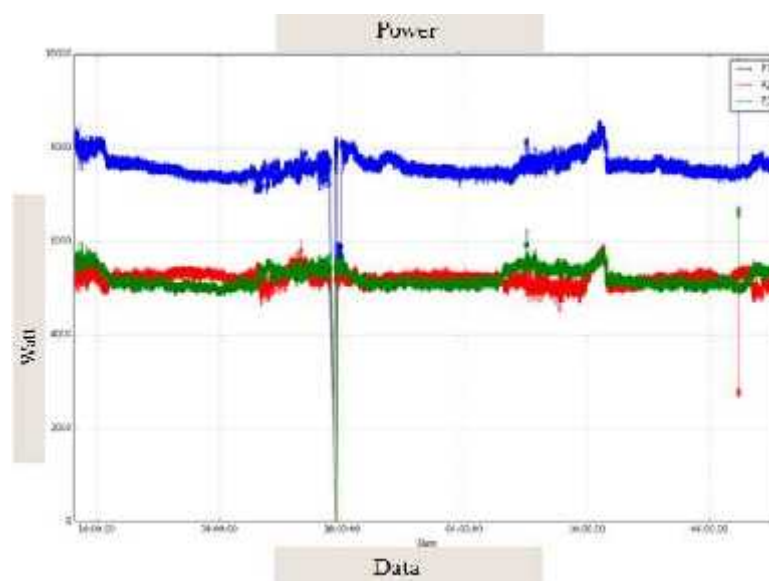

Fig 4. Power Monitoring Implementation

The graph of power monitoring shows that on Phase 1 that is highly loaded with average 8.000 Watt, phase 2 and phase 3 energy consumption was lower than Phase 1.

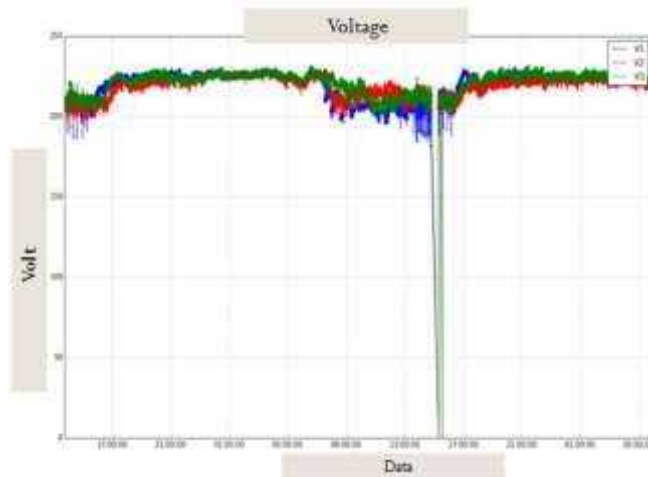

Fig 5. Voltage Monitoring Implementation

On Fig. 5. shows that phase voltage tends to be stable in range between 200 V to 230 V.

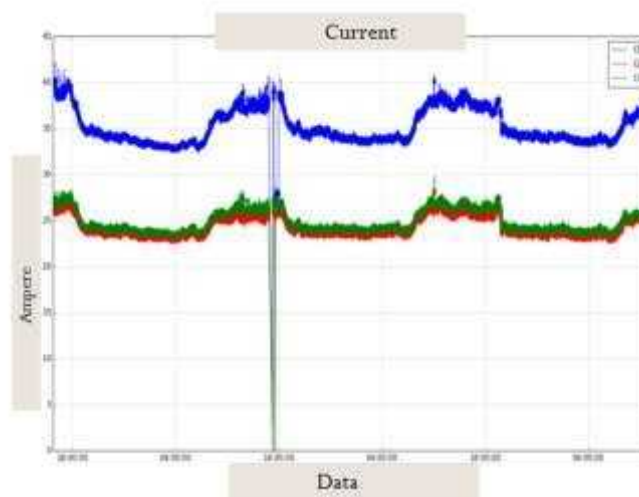

Fig 6. Current Monitoring Report

Fig. 6. shows report of current value, it shows that current on Phase 1 was the highest current as compared with other current on Phase 2 or Phase 3. This data is in line with power consumption report on Fig. 4.

#### 4.3. Bandwidth Monitoring

BGP server bandwidth utilization, graphs was taken on September 3, 2015. It presents bandwidth usage started to increase at 8 am to 4 pm during Unila working hours. After 4pm bandwidth usage began to decline and reach its lowest condition on 4 am until 8 am.

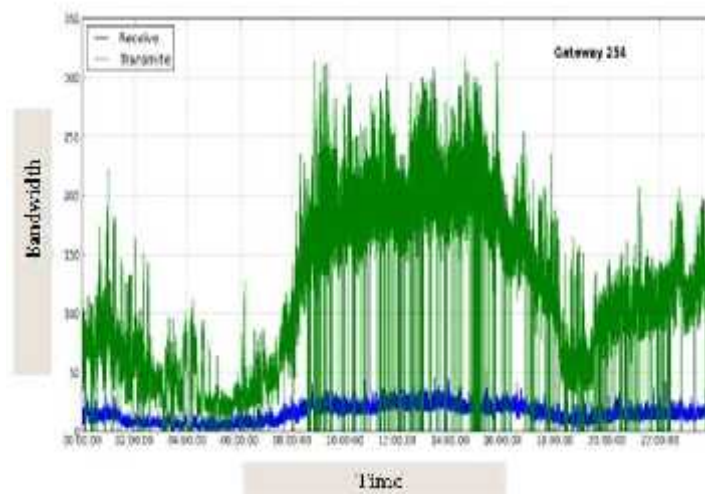

Fig 7. Daily Bandwidth Usage Statistic

#### 4.4. Temperature Monitoring Implementation

Dallas sensor DS18B20 is used to get temperature data, consist of 3 units placed on different place on Data Centre room , maximum temperature above 28.13oC , the lowest temperature of 16.8oC. High temperature happened because all of Air Conditioner (AC) on Data Centre room didn't work. as well.

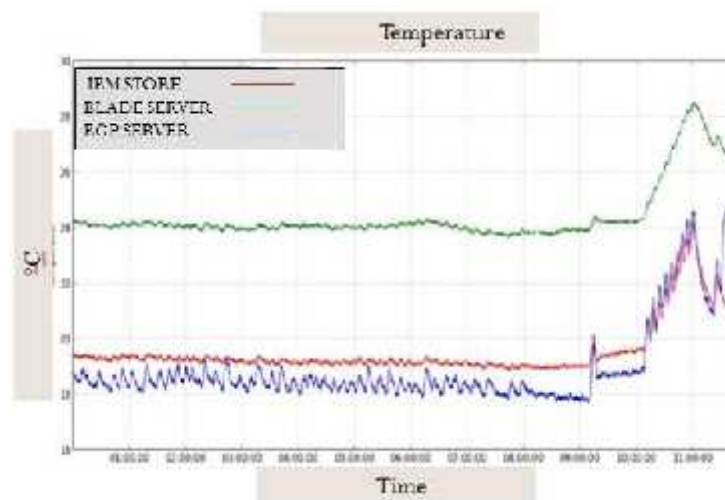

Fig 8. Temperature Report

## V. Conclusions

System monitoring provided interactive live report to help IT management analyzing and evaluating the electricity and internet connection SLA. Results monitoring of 3-phase electrical system at a data center “Unit Pelayanan Teknis Teknologi Informasi dan Komunikasi-Universitas Lampung (UPT.TIK UNILA)” shows that phase voltage tends to be stable in 200 V to 230 V. The lowest voltage occur when peak load at 11 am to 2 pm, because of the tendency of the use of equipment electricity at that time. For bandwidth usage increase during working hours at 8 am to 4 pm, which indicates the number of users is still focus in daylight. While temperatures, the result shows higher temperature in the day at 10 am until 1 pm, because of the influence of the outdoor temperature.

## References

- [1]. Besma, D Despa, Noer. S, "Rancang Bangun Alat Pemutus Aliran Daya Listrik Melalui Fasilitas SMS Berbasis Mikrokontroler", JITET, 2013.
- [2]. Cisco, "Data Center Power And Cooling," White Paper, p. 3, 2011.
- [3]. D. A. Rusti, A. R. Nansur and M. Safrodin, "Monitoring Pemakaian Energi Listrik Berbasis Mikrokontroler Secara Wireless," EEPIS Repository, 2011.
- [4]. Dikpride Despa, Yasunori Mitani, Masayuki Watanabe, Yaser Soleman Qudaih, Taro Fujita, Qing Liu, Michael Bernard, "PMU Based Monitoring and Estimation Power System Dynamic Stability Developed on 50-Hz Power System", Proceeding of Power and Energy Systems (AsiaPES 2012), 2012.
- [5]. Dikpride Despa, Yasunori Mitani, Masayuki Watanabe, Changsong Li, "PMU Based Monitoring and Estimation of Inter-area Power Oscillation for Singapore-Malaysia Interconnection Power System", Journal of Energy and Power Engineering ISSN 1934-8975, USA, Vol.6, Number 3, Pp.463-468, March 2012
- [6]. Dikpride Despa, Ady Kurniawan, M. Komarudin, Mardiana, Gigih F N, "Smart Monitoring of Electrical Quantities Based on Single Board Computer BCM2835", Proceedings ICITACEE 2015, The 2nd International Conference on Information Technology, Computer dan Electrical Engineering, Semarang, 2015.
- [7]. Gigih Forda Nama, Hery Dian Septama, Lukmanul Hakim, dan Muhamad Komarudin "Rancang Bangun Sistem Monitoring Sambungan Internet Universitas Lampung Berbasis Mini Single Board Computer Bcm2835", Prosiding Seminar Nasional Sains & Teknologi V, 2013.
- [8]. Gigih F N, M Komarudin, Hanang P, Mardiana, and Hery D S, "Electricity, Temperature, and Network Utilization Monitoring at Lampung University Data Centre Using Low Cost Low Power Single Board Mini Computer", International conference RC-CIE, Yogyakarta Indonesia, 2014. Pp 184-189, 2014.
- [9]. Kortuem, G., Kawsar, F., Fitton., D., Sundramoorthy, V., " Smart objects as building blocks for the internet of things. Internet Computing", IEEE, vol. 14, no.1, 44-51 (2010)
- [10]. Mardiana, Wahyu Eko S, et.al, "Sistem Monitoring Server Berbasis SMS (Studi Kasus : Server Siacad Unila)", Electrician, Jurnal Rekayasa dan Teknologi FT Unila Vol.2.No.3, 2008.
- [11]. Wahyu Eko S, Mardiana, Nasrul Fatoni, "Web Service Sebagai Penyedia Layanan Pada Sistem Informasi Manajemen Jurusan", Electrician, Jurnal Rekayasa dan Teknologi FT Unila, Vol.3.No.3 , 2009.
- [12]. Mardiana, Araki, K., Omori, Y., " MDA and SOA approach to development of web application interface " , Proceeding of International Conference on TENCON 2011, IEEE, 2011
- [13]. Muhammad Arif, Dikpride Despa, et.al, "Rancang Bangun Pengatur Suhu ruangan Tanaman Jamur Tiram Menggunakan Mikrokontroler Atmega16", Jurnal Ilmiah Teknik Pertanian (TekTan), Vol 4, 2012
- [14]. Reza Pradikta, Achmad Affandi, Eko Setijadi, "Rancang Bangun Aplikasi Monitoring Jaringan dengan Menggunakan Simple Network Management Protocol", TEKNIK POMITS, vol. 2, no. 1, pp. A 154 - A 158, 2013.
- [15]. Riyanto and R. O. Wayagi, "Sistem Monitoring Suhu Ruang Server Berbasis Web dengan Menggunakan EZ430," Jurnal Ilmiah, vol. 2, no. 1, pp. 50-54, 2011.
- [16]. Rusfita Rahayu, Idris Winarno, "Aplikasi Management Bandwidth Berbasis Web Menggunakan Pengalamatan IPv6, Jurnal Ilmiah, vol. 2, no. 1, 2011.
- [17]. Pei Zhang, Fangxing Li, and Navin Bhatt, " Next-Generation Monitoring, Analysis, and Control for the Future Smart Control Center" IEEE.
- [18]. Qing Liu, Dikpride Despa, Yasunori Mitani. Application of Phasor and Node Voltage Measurements to Monitoring Power Flow Stability. International Journal on Electrical Engineering and Informatics. Printed ISSN 2085-6830/Online e-ISSN 2087-5886 Vol. 4, Number 3, Pp. 276-288, July 2012